

The background is a dark teal color. On the left side, there are several overlapping curved shapes in a gradient of dark teal to black, creating a sense of depth and movement. The text is positioned in the upper right quadrant.

systemtronic

**CROMA
COLLECTION**



INDEX INDICE

06	LAGRANJA DESIGN
12	CROMA COLLECTION
18	CROMA BENCH
22	CROMA PLANTER BENCH
26	CROMA PLANTER
30	CROMA LUGGAGE STAND
34	CROMA WARDROBE
38	CROMA VALET STAND
42	CROMA TABLES
46	CROMA SHELVING
52	CROMA TROLLEY
56	CROMA PAPER BIN
60	CROMA MIRROR
68	ENVIRONMENTS
70	CROMA FINISHES
72	MORE OF SYSTEMTRONIC
74	CONTACT



Thought to create
**CROMA
 COLLECTION**

From the continuous analysis of the new ways of experiencing spaces, emerges the Croma collection, designed by the Lagranja Design studio: curved lines, materials and finishes inspired by the warmth of the Mediterranean. Furniture that blurs the boundaries between art, decor and design. The collection includes several complementary functions: valet stand, wardrobe, mirror, side tables, trolley, planters, paper bins, luggage stand, shelving, and benches with or without planters. Their volumes, which do not lose sight of Systemtronic's commitment to sustainability, offer a palette of deep and saturated colors.

The combination of pieces in white ash, in its natural or stained version, with others in painted or chrome plated aluminum, results in fun, almost playful, furniture which is easily recognizable thanks to its geometric consistency. A key modern collection which incorporates organic shapes and explores all that is different, emotional and serene.

Del continuo análisis de los nuevos modos de vivir los espacios surge la colección Croma, diseñada por el estudio Lagranja Design: líneas curvas, materiales y acabados inspirados en la calidez mediterránea, muebles que difuminan las fronteras entre arte, decoración y diseño. La colección incluye varias funciones complementarias: galán de noche, vestidor, espejo, mesas auxiliares, camarera, jardineras, papeleras, maletero, estanterías y bancos con o sin jardinera. Sus volúmenes, que no pierden de vista la apuesta de Systemtronic por la sostenibilidad, cuentan con una paleta de colores profundos y saturados.

La combinación de piezas de fresno blanco, en su versión natural o teñida, con otras de aluminio pintadas o cromadas, dan como resultado muebles divertidos, casi lúdicos, que son fácilmente reconocibles como un todo por su coherencia geométrica. Una colección en clave actual que incorpora formas orgánicas y explora lo diferente, lo emocional y lo sereno.





**CROMA
COLLECTION**

CROMA BENCH

Designed to transform the interior of any space, this aluminum bench is more than just a seat.

Its M and L sizes enhance its adaptability. The visible legs add a touch of sophistication, especially in its chrome version, while the natural ash wood veneer top brings warmth and authenticity.

We envision this piece at the foot of a bed or as the perfect complement for that hallway we walk through every day.

Diseñado para transformar el interior de cualquier espacio, este banco de aluminio es mucho más que un asiento.

Sus medidas M y L aumentan su adaptabilidad. Las visibles patas añaden un toque de sofisticación, sobre todo en su versión cromada, mientras que la madera de fresno natural del sobre agrega calidez y autenticidad.

Imaginamos esta pieza a los pies de una cama o como el complemento perfecto para ese pasillo por el que circulamos a diario.



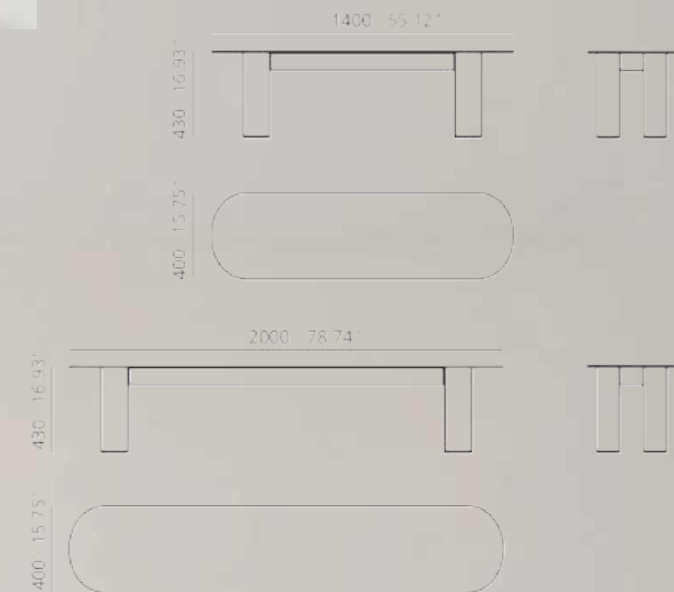

Aluminum bench available in two sizes. The seating area can be ordered with ash veneer in either a natural or lacquered finish.

Banco de aluminio disponible en dos tamaños. La zona de asiento puede solicitarse chapada en fresno de acabado natural o lacado.

CROMA PLANTER BENCH

The perfect duality between elegance and functionality. This versatile bench, available in S and M sizes, is crafted in aluminum to withstand the test of time.

Its top, either in natural ash veneer or with a cozy cushion, transforms the seat into a unique experience, while its geometry escapes from right angles, conveying calmness and modernity to any interior.

Envision this bench as an oasis of serenity in a living room, or as a touch of freshness in a foyer.

La dualidad perfecta entre elegancia y funcionalidad. Este versátil banco, disponible en medidas S y M, está diseñado en aluminio para resistir el paso del tiempo.

Su sobre, ya sea en fresno natural o con un cómodo cojín, transforma el asiento en una experiencia única, mientras que su geometría escapa de los ángulos rectos y transmite calma y modernidad a cualquier interior.

Imaginamos este banco como un oasis de serenidad en una sala de estar, o como un toque de frescura en un recibidor.



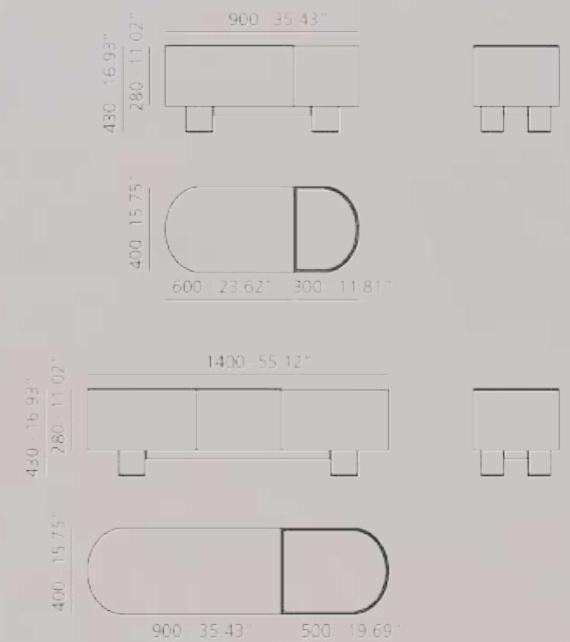

This elegant piece of furniture made of aluminum and available in two sizes can be used both as comfortable seating solution and practical planter offering a natural focal point for decoration.

Esta elegante pieza de mobiliario fabricada en aluminio y disponible en dos tamaños, sirve a la vez como una cómoda solución de asiento y como una práctica jardinera que ofrece un punto focal natural para la decoración.

CROMA PLANTER

Available in three different sizes, with capacities that adapt to any need.

Their round shape adds a contemporary touch, while the legs not only maintain the formal coherence of the collection but also elevate the planters, providing a unique visual and facilitating their mobility.

In addition to their aesthetic appeal, they offer a practical solution for plant cultivation, creating a green and relaxing environment. Ideal for a wide variety of spaces, from discreet living rooms to large hotel lobbies.

Disponibles en tres tamaños distintos, con capacidades que se adaptan a cualquier necesidad.

Su forma redonda agrega un toque contemporáneo, mientras que las patas no solo mantienen la coherencia formal de la colección, sino que también elevan las jardineras, proporcionando una visual única y facilitando su movilidad.

Además de su atractivo estético, ofrecen una solución práctica para el cultivo de plantas, creando un entorno verde y relajante. Son ideales para una amplia variedad de espacios, desde discretas salas de estar hasta grandes vestíbulos de hoteles.



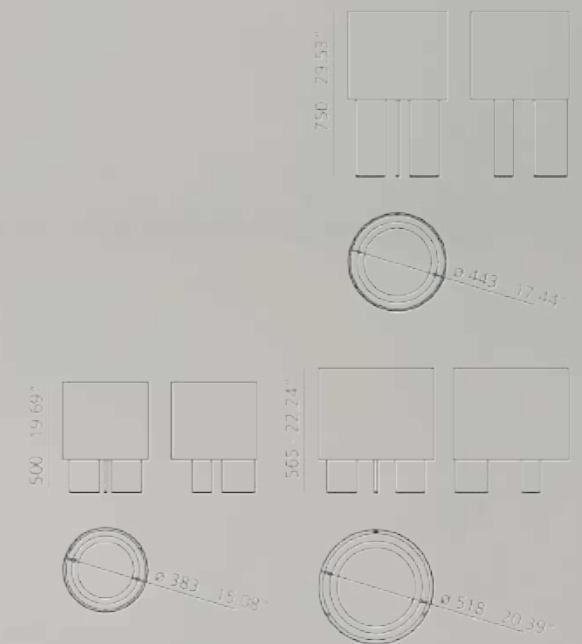

Made of aluminum and available in three different sizes, with capacities of 15, 36, and 40 liters.

Fabricadas en aluminio y disponibles en tres tamaños diferentes, con capacidad de 15, 36 y 40 litros.

CROMA LUGGAGE STAND

A piece of furniture that not only proves ideal for storing belongings but also enhances the user experience in the living space, all while sharing the characteristic formal unity of the entire collection.

The top shelf's ash veneer can be in a natural or lacquered finish. Ideal for placement in hotel rooms.

Un mueble que no solo resulta ideal para almacenar pertenencias, sino que también mejora la experiencia del usuario en el espacio que habita, al tiempo que comparte la unidad formal característica de toda la colección.

El chapado de fresno de la balda superior puede ser en acabado natural o lacado. Ideal para colocar en habitaciones de hotel.

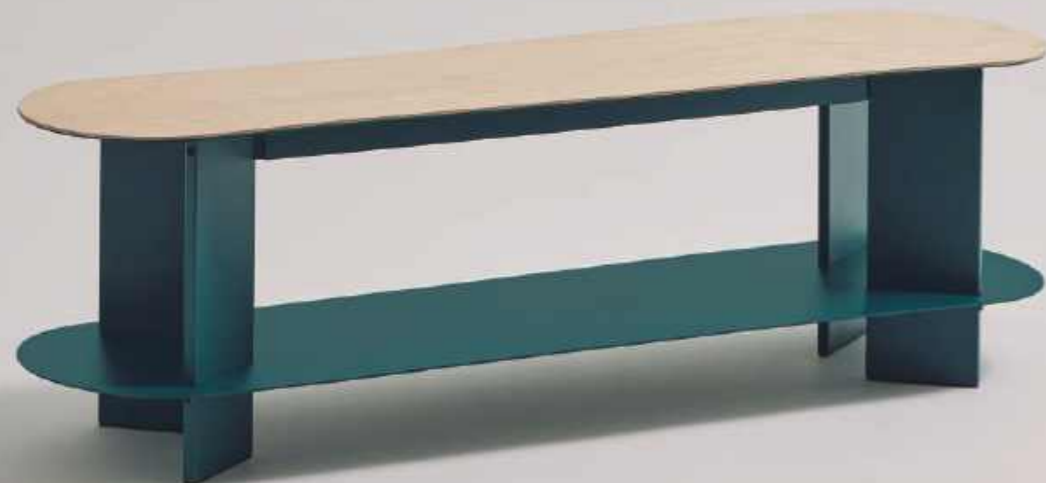

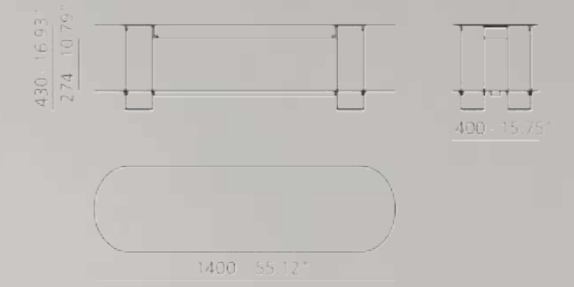

Made of aluminum. The top shelf can be ordered with ash veneer in either a natural or lacquered finish.

Fabricado en aluminio. El estante superior puede solicitarse chapado en fresno de acabado natural o lacado.

CROMA WARDROBE

The natural ash arch adds a touch of warmth and transforms this wardrobe into more than just a simple place to accommodate garments.

Its two strategically placed shelves allow for the tidy and accessible storage of everything from shoes to handbags. The chrome option for the four legs that traverse the first shelf becomes a statement of intention for any space.

El arco de fresno natural agrega un toque de calidez y transforma este armario en algo más que un simple lugar para acomodar prendas.

Sus dos estantes estratégicamente ubicados permiten mantener ordenados y al alcance de la mano desde zapatos hasta bolsos. La opción cromada de las cuatro patas que atraviesan el primer estante se convierte en una declaración de intenciones para cualquier espacio.



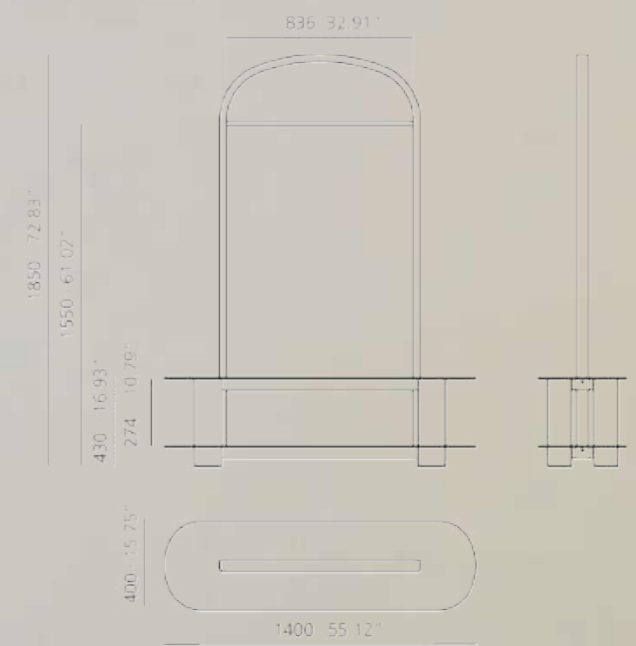

This open wardrobe, with two shelves and rail with an approximate capacity for between 10 and 15 garments, combines an aluminum structure with a solid ash arch in a natural or lacquered finish.

Este vestidor de dos estantes y percha con capacidad aproximada de entre 10 y 15 prendas, combina su estructura de aluminio con un arco de fresno macizo en acabado natural o lacado.

CROMA VALET STAND

A piece of furniture designed to adorn the areas where we undress and surrender to the warmth of 'at-home' attire.

Every detail is crafted to enhance the beauty of the daily routine. Its geometry blends the durability of aluminum with the warmth of natural ash, adding a touch of distinction to the space.

Una pieza de mobiliario diseñada para decorar las zonas donde nos desvestimos y nos rendimos a la calidez de las prendas de "andar por casa".

Cada detalle está pensado para realzar la belleza de la rutina diaria. Su geometría combina la durabilidad del aluminio con la calidez del fresno natural y añade un toque de distinción al espacio.



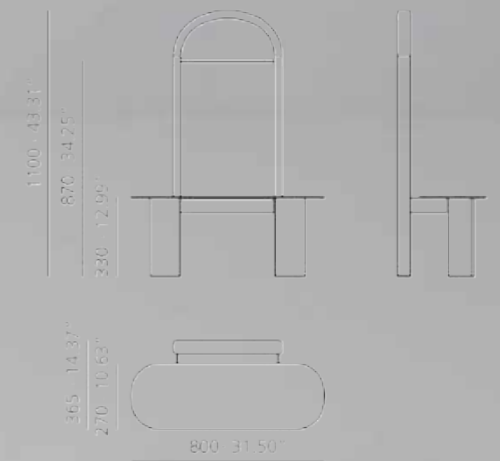

The structure is manufactured in aluminum and the arch in solid ash with a natural or lacquered finish.

The legs can be ordered in a chrome finish.

La estructura está fabricada en aluminio y el arco en fresno macizo en acabado natural o lacado.

Sus patas pueden solicitarse cromadas.

CROMA TABLES

The collection includes two coffee tables, a side table, and a bedside table.

The round tabletops add a modern and sophisticated touch, creating an attractive and harmonious aesthetic. Ideal for those often overlooked corners where they will undoubtedly capture the attention of every visitor.

La colección incluye dos mesas de centro, una mesa auxiliar y una mesa de noche.

Los tableros circulares añaden un toque moderno y sofisticado, creando una estética atractiva y armoniosa. Ideales para esos rincones muchas veces olvidados donde sin duda atraparán la atención de todo visitante.



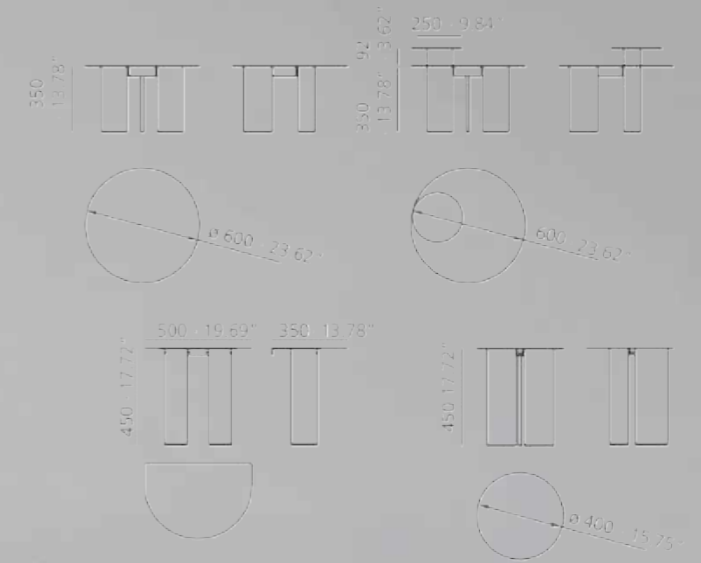

Made of aluminum. The tabletop can be veneered with ash in a natural or lacquered ash, as well as chrome its legs.

Fabricadas en aluminio. Se ofrece la posibilidad de chapar su sobre con fresno en acabado natural o lacado, así como de cromar sus patas.

CROMA SHELVING

With two models featuring two shelves, distinguished by their size, and a third model with three shelves, these shelving units offer a practical and stylish solution for organizing your spaces with a distinctive touch.

The shelves and uprights are made of aluminum, ensuring durability and strength without sacrificing lightness and versatility. The arches are crafted from natural ash wood. The curved ends of the shelves are not only aesthetic but also functional, preventing sharp corners and adding an ergonomic touch.

The contrast of materials highlights their quality while adding character to each piece. Whether in the living room, office, or any other space, these shelving units are ideal for displaying books, decorative objects, or everyday items.

Con dos modelos de dos estantes, diferenciados por su tamaño, y un tercer modelo de tres estantes, estas estanterías ofrecen una solución práctica y estilizada para organizar tus espacios con un toque distintivo.

Las baldas y los montantes están fabricados en aluminio, que garantiza durabilidad y resistencia sin sacrificar la ligereza y la versatilidad. Los arcos son de fresno natural. Los extremos curvos de las baldas no solo son estéticos, sino también funcionales al prevenir esquinas afiladas y añadir un toque ergonómico.

El contraste de materiales resalta la calidad de los mismos, al tiempo que agrega carácter a cada pieza. Ya sea en el salón, la oficina o cualquier otro espacio, estas estanterías son ideales para exhibir libros, objetos decorativos o elementos de uso cotidiano.



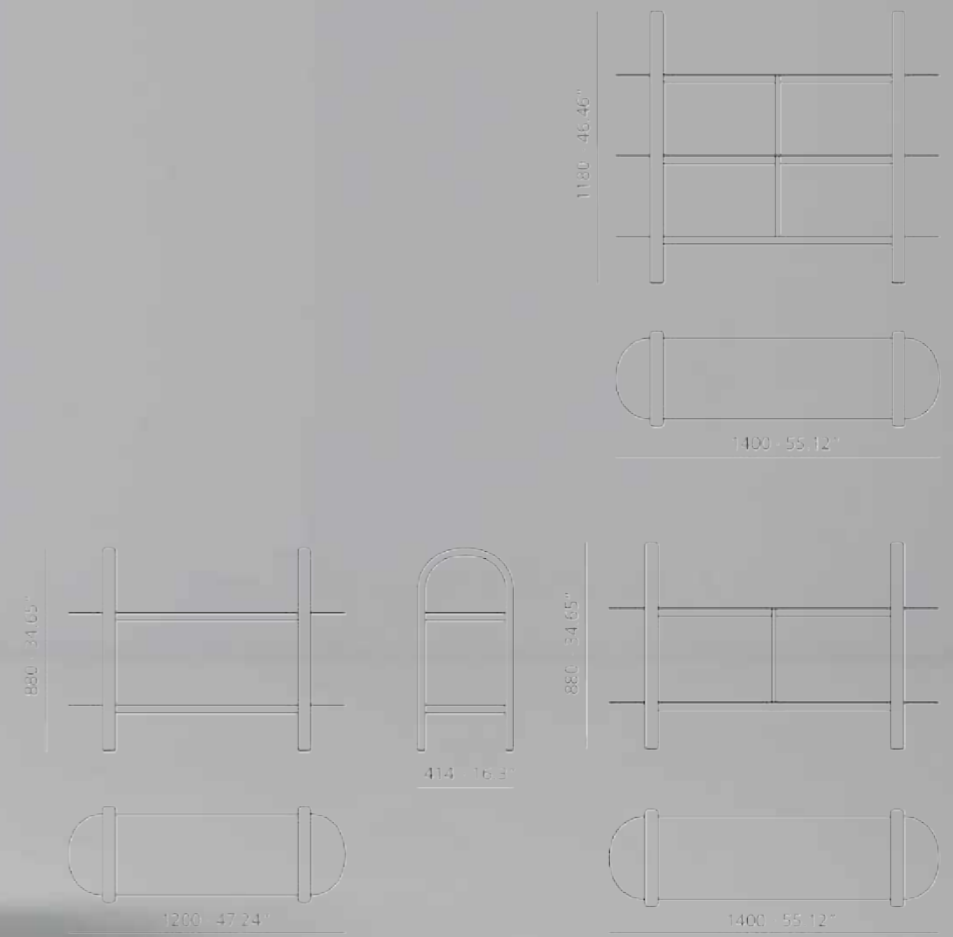

The shelves and uprights are made of aluminum, while the arches are made of natural ash.

Los estantes y los montantes están fabricados en aluminio, y los arcos, en fresno natural.



CROMA TROLLEY

Crafted to elevate everyday moments, this exceptional piece seamlessly blends functionality and aesthetics in a unique design.

The arc of natural ash not only adds elegance but also bridges the gap between the classic and the modern. The large wheels made of natural ash, in addition to facilitating mobility, bring a touch of fun.

This is more than just a piece of furniture; it's a statement of style. Whether in a living room, a kitchen, or a dining room, the aluminum Croma Trolley is destined to capture attention.

Creada para elevar los momentos cotidianos, esta pieza excepcional fusiona funcionalidad y estética en un diseño único.

El arco de fresno natural no solo añade elegancia, sino que también crea un puente entre lo clásico y lo moderno. Las grandes ruedas de fresno natural, además de facilitar el desplazamiento, aportan un toque de diversión.

Esta no es solo una pieza de mobiliario; es una declaración de estilo. Ya sea en una sala de estar, una cocina o un comedor, la Camarera Croma de aluminio está destinada a no pasar desapercibida.



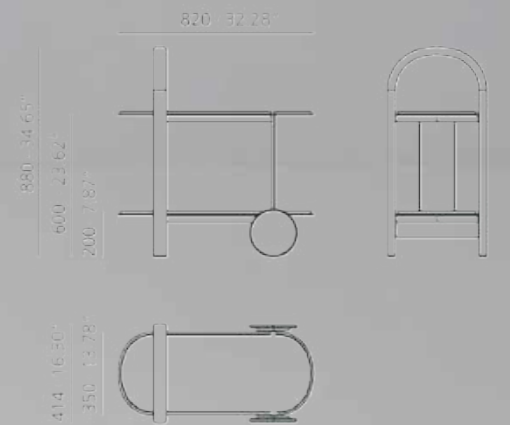

It boasts two shelves joined by a solid ash arch and an aluminum frame which can be requested in chrome plating or painted in any of the colors from the collection. Its large wheels, also in ash, make it easier to move around while also enhancing its playful geometry.

Cuenta con dos estantes unidos por un arco de fresno macizo y un montante de aluminio que puede solicitarse cromado o pintado en cualquiera de los colores de la colección. Sus grandes ruedas, también de fresno, favorecen su desplazamiento a la vez que refuerzan su geometría lúdica.

CROMA PAPER BIN

These waste bins are not just containers; they are a statement of commitment to recycling and sustainability.

Featuring clearly differentiated compartments, they make the task of separating waste easy, thus contributing to the global initiative of environmental conservation.

Their clean and modern design not only seamlessly integrates into any environment but also challenges the traditional perception of waste bins as unattractive elements. Instead of hiding them away, they invite you to proudly display them, making them an integral part of the decor. Elevated from the floor by discreet legs, it becomes easier to keep the space around them clean.

Estas papeleras no son solo contenedores, son una declaración de compromiso con el reciclaje y la sostenibilidad.

Con compartimentos claramente diferenciados, facilitan la tarea de separar residuos, contribuyendo así a la iniciativa global de proteger el medioambiente.

Su diseño limpio y moderno no solo se integra armoniosamente en cualquier entorno, sino que también desafía la percepción tradicional de las papeleras como elementos poco atractivos. En lugar de esconderlas, invitan a exhibirlas con orgullo, convirtiéndolas en parte integral de la decoración. Al estar elevadas del suelo por medio de discretas patas, resulta más fácil mantener limpio el espacio a su alrededor.



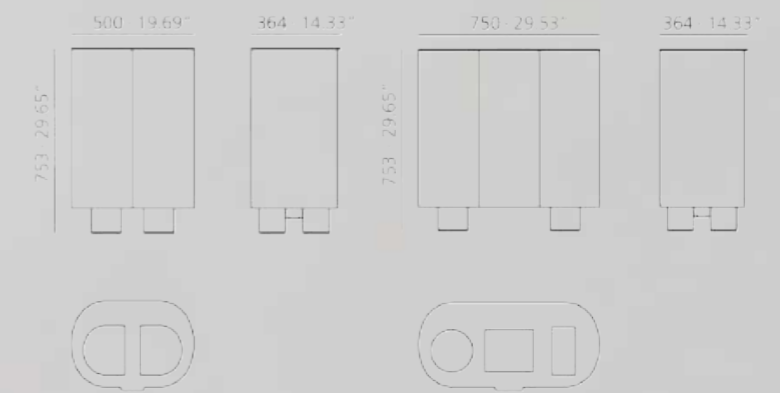

Made of aluminum and available in two different sizes, with capacities of 100 and 160 liters (one 50-liter trash bag per compartment).

Fabricadas en aluminio y disponibles en dos tamaños diferentes, con capacidad de 100 y 160 litros (1 bolsa de 50 litros por compartimento).

CROMA MIRROR

Crafted to stand out in any setting, this freestanding floor mirror features a distinctive tilt and a curved top that sets it apart.

It is available in all the vibrant finishes from the collection. Ideal for bedrooms and living rooms, where it becomes the perfect companion for those final touches before stepping out.

Diseñado para destacar en cualquier entorno, este espejo de pie autoportante presenta una inclinación distintiva y un remate curvo que lo hace único.

Está disponible en todos los vibrantes acabados de la colección. Resulta ideal para dormitorios y salas de estar, donde se vuelve el compañero perfecto para esos últimos retoques antes de salir.





The self-supporting design of this free-standing mirror makes it more flexible to use and eliminates the need to drill holes into the walls for its installation.

El diseño autoportante de este espejo de pie hace más flexible su uso y evita el tener que taladrar las paredes para su montaje.





ENVIRONMENTS



MORE OF SYSTEMTRONIC



Ker

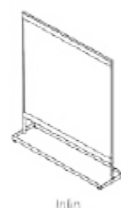

Inlin



Porito



Celis



Lurni



Mil



Parbar

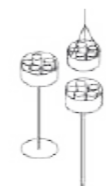

Green Cloud



Malva

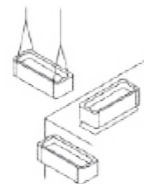

Green Light

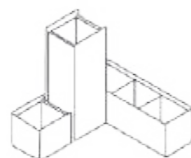

Grape

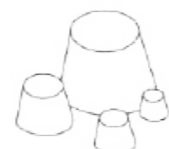

Conee

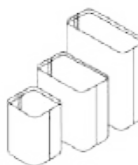

Drop

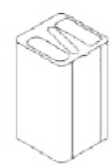

Drop Top Triple

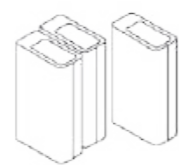

Drop Top

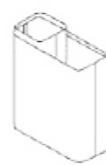

Drop Out

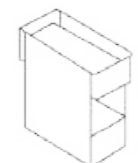

Hold

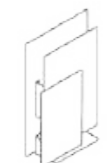

Sou

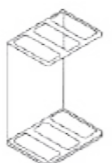

Forrin



Flora

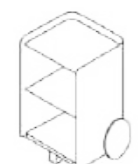

Ben

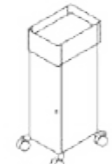

Hold Daily

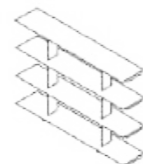

Wing



Naname

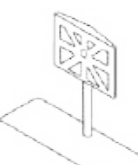

Sito

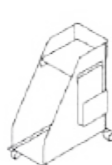

Store

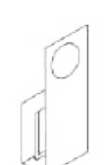

Buraco



Cromi



Eica Mini



Dina



Cantha



Inper

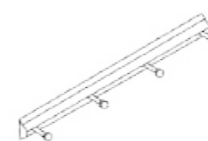

Climb



Nube



Eica



Faye



Branch

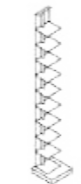

Usio

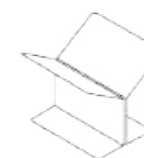

Mott

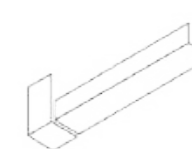

Baldes

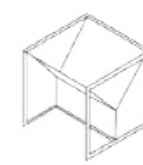

Zin



Lit



Trec



Furi



Flap



Flag



Modulor



Atria

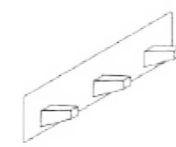

Second Tree Wall



Second Tree



Koku