

# Wing

systemtronic



The Wing collection is a very versatile modular furniture system made of extruded aluminum. Its design is discreet, with a structure of essential shapes and shelves of subtle profiles that instill an expression of lightness and sophistication into the piece. The modules can be configured in multiple ways and heights to suit diverse needs and spaces, both in the contract and residential environments. The option to integrate sliding panels, oak or technical stone covers on the top shelf, as well as various accessories, serves to enhance and complement the functional nature of the system. ENG

La colección Wing es un sistema de muebles modulares muy versátil de aluminio extruido. Su diseño es discreto, con una estructura de formas esenciales y estantes de perfiles sutiles que otorgan a la pieza una imagen de ligereza y sofisticación. Los módulos pueden configurarse de múltiples formas y alturas para responder a diversas necesidades y espacios, tanto en el ámbito *contract* como en el residencial. La opción de integrar paneles deslizantes, embellecedores de roble o piedra técnica sobre el estante superior, así como otros accesorios, contribuye a ampliar y complementar la naturaleza funcional del sistema. ESP

# Wing



At Systemtronic, we understand that working sustainably lays the foundations for an eco-efficient model which contributes to the reduction of our environmental footprint. The flexible and extremely adaptable design of the products in the Wing collection allows them to be reused, resulting in a longer lifespan. They are made with 100 % recyclable materials. At least 25 % of the aluminum used is recycled. The paints do not contain solvents, do not consume water and do not generate emissions or waste. The incorporated fabrics are made entirely of recycled material and its manufacturing process does not generate any rubbish. The result is a lower environmental impact.

ENG

En Systemtronic entendemos que el quehacer sostenible sienta las bases de un modelo eco-eficiente que contribuye a reducir la huella ambiental. El diseño flexible y extremadamente adaptable de los productos de la colección Wing permite la reutilización de los mismos, lo que hace que su vida útil sea más larga. Los materiales con que se fabrican son 100 % reciclables. Al menos el 25 % del aluminio utilizado es reciclado. Las pinturas usadas no contienen disolventes, no consumen agua y no generan emisiones ni vertidos. Por su parte, los tejidos incorporados están compuestos enteramente por material reciclado y su proceso de fabricación no genera ningún residuo. El resultado es un impacto medioambiental menor.

ESP

# Modular means sustainable



## WING COLLECTION

- 18 1600 WALL SHELVES • ESTANTERÍAS DE PARED
- 32 1600 FREESTANDING SHELVES • ESTANTERÍAS *FREESTANDING*
- 48 1600 CORNER SHELVES • ESTANTERÍAS DE ESQUINA
- 64 800 WALL SHELVES • ESTANTERÍAS DE PARED
- 70 800 FREESTANDING SHELVES • ESTANTERÍAS *FREESTANDING*
- 76 DESK • ESCRITORIO
- 80 WARDROBE • ARMARIO
- 84 BENCH • BANCO
- 88 TV STAND • SOPORTE TV
  
- 92 ACCESSORIES • ACCESORIOS
- 107 TECHNICAL DETAILS • DETALLES TÉCNICOS
- 123 COMPOSITIONS • COMPOSICIONES
- 139 FINISHES • ACABADOS

# Index



Modular wall shelves, 1600 mm wide. The shelves, with rounded corners, have trims on both ends that conceal the interior of the profile. It has wall hooks designed to be flexible in case of unevenness. The bases measure 250 mm. It is possible to integrate 400 mm and 800 mm sliding panels, in front or rear position. Combinable with the rest of the references in the collection. The maximum recommended height is seven shelves.

ENG

Estantería modular de pared de 1600 mm de ancho. Los estantes, de ángulos redondeados, tienen embellecedores en ambos extremos que ocultan el interior del perfil. Lleva enganches a pared pensados para ser flexibles ante cualquier desnivel. Las bases miden 250 mm. Es posible integrar paneles deslizantes de 400 mm y 800 mm, en posición frontal o posterior. Combinable con el resto de referencias de la colección Wing. La altura máxima recomendada es de siete estantes.

ESP

# 1600 Wall Shelves







1600 Wall Shelves /  
7 shelves / rust rame

Accessories:  
(6x) 800 mm panels /  
beige red



1600 Wall Shelves /  
5 shelves / rust rame



Panels and  
shelves in  
different  
colors



COMPOSITION 3  
1600 Wall Shelves  
1600 Freestanding Shelves  
page 126













Modular freestanding shelves, 1600 mm wide. The shelves, with rounded corners, have trims on both ends that conceal the interior of the profile. Versions up to three shelves high have 250 mm bases. To ensure stability, versions from a height of four shelves on come with 420 mm bases that can be concealed using a cover. It is possible to integrate 400 mm and 800 mm sliding panels, in front or rear position. Combinable with the rest of the references in the collection. The maximum recommended height is seven shelves.

ENG

Estantería modular *freestanding* de 1600 mm de ancho. Los estantes, de ángulos redondeados, tienen embellecedores en ambos extremos que ocultan el interior del perfil. Las versiones de hasta tres estantes de altura llevan bases de 250 mm. Para garantizar la estabilidad, a partir de cuatro estantes lleva bases de 420 mm que pueden ocultarse con un embellecedor. Es posible integrar paneles deslizantes de 400 mm y 800 mm, en posición frontal o posterior. Combinable con el resto de referencias de la colección Wing. La altura máxima recomendada es de siete estantes.

ESP

# 1600 Freestanding Shelves



COMPOSITION 5  
1600 Wall Shelves  
1600 Freestanding Shelves  
page 127



1600 Freestanding Shelves /  
3 shelves / reseda green



1600 Freestanding Shelves /  
6 shelves / reseda green

Accessories:  
(4x) 800 mm panels /  
black

Color change:  
(4x) color change of a  
1600 mm shelf unit / black  
(4x) color change of a  
vertical upstand unit / black



The perfect  
way to separate  
environments



COMPOSITION 6  
1600 Freestanding Shelves  
page 128





Do you like  
to read?



COMPOSITION 7  
1600 Wall Shelves  
1600 Freestanding Shelves  
page 128





We look up to  
architecture





Corner freestanding, 1600 mm inner width. Each level comprises right-side and left-side shelves, joined by two inner flat bars that fix them in place. The shelves, with rounded corners, have trims on both ends that conceal the interior of the profile. Its corner arrangement and its strong joints give this model great stability, which allows it to keep the measurement of its bases at 250 mm, without the need to use wall or floor anchorings. It is possible to integrate sliding panels of 725 mm and 1125 mm, in front or rear position. Combinable with the rest of the references in the collection. The maximum recommended height is seven shelves.

ENG

Estantería esquinera de 1600 mm de ancho interior. Cada nivel está compuesto por estantes de lateral derecho e izquierdo, unidos mediante dos pletinas en su interior que sirven para fijarlos. Los estantes presentan esquinas redondeadas y embellecedores en los extremos que ocultan el interior del perfil. Su disposición en esquina y sus fuertes uniones dotan a este modelo de gran estabilidad, lo que permite mantener la medida de sus bases en 250 mm, sin necesidad de enganches a pared o a suelo. Es posible integrar paneles deslizantes de 725 mm y 1125 mm, en posición frontal o posterior. Combinable con el resto de referencias de la colección Wing. La altura máxima recomendada es de siete estantes.

ESP



# 1600 Corner Shelves







Open to  
new horizons











1600 Corner Shelves /  
6 shelves / silk grey



1600 Corner Shelves /  
6 shelves / silk grey

Accessories:

(6x) 400 mm panels / bronze bagana

(6x) 800 mm panels / bronze bagana

(6x) 725 mm panels / bronze bagana



Ideal for making  
the most of space







Modular wall shelves, 800 mm wide. The shelves, with rounded corners, have trims on both ends that conceal the interior of the profile. It is supported on 250 mm bases and wall hooks designed to adapt to possible unevenness. Optionally, it can integrate 800 mm sliding panels, in front or rear position. Combinable with the rest of the references in the collection. The maximum recommended height is seven shelves.

ENG

Estantería modular de pared de 800 mm de ancho. Los estantes, de ángulos redondeados, llevan embellecedores en ambos extremos para ocultar el interior del perfil. Se sustenta sobre bases de 250 mm y enganches a pared previstos para adaptarse a posibles desniveles. Opcionalmente puede integrar paneles deslizantes de 800 mm, en posición frontal o posterior. Combinable con el resto de referencias de la colección Wing. La altura máxima recomendada es de siete estantes.

ESP

# 800 Wall Shelves





800 Wall Shelves /  
2 shelves / rust rame



From a  
bedside  
table to a  
bookshelf

800 Wall Shelves /  
7 shelves / rust rame

Accessories:  
(5x) 800 mm panels /  
silk grey



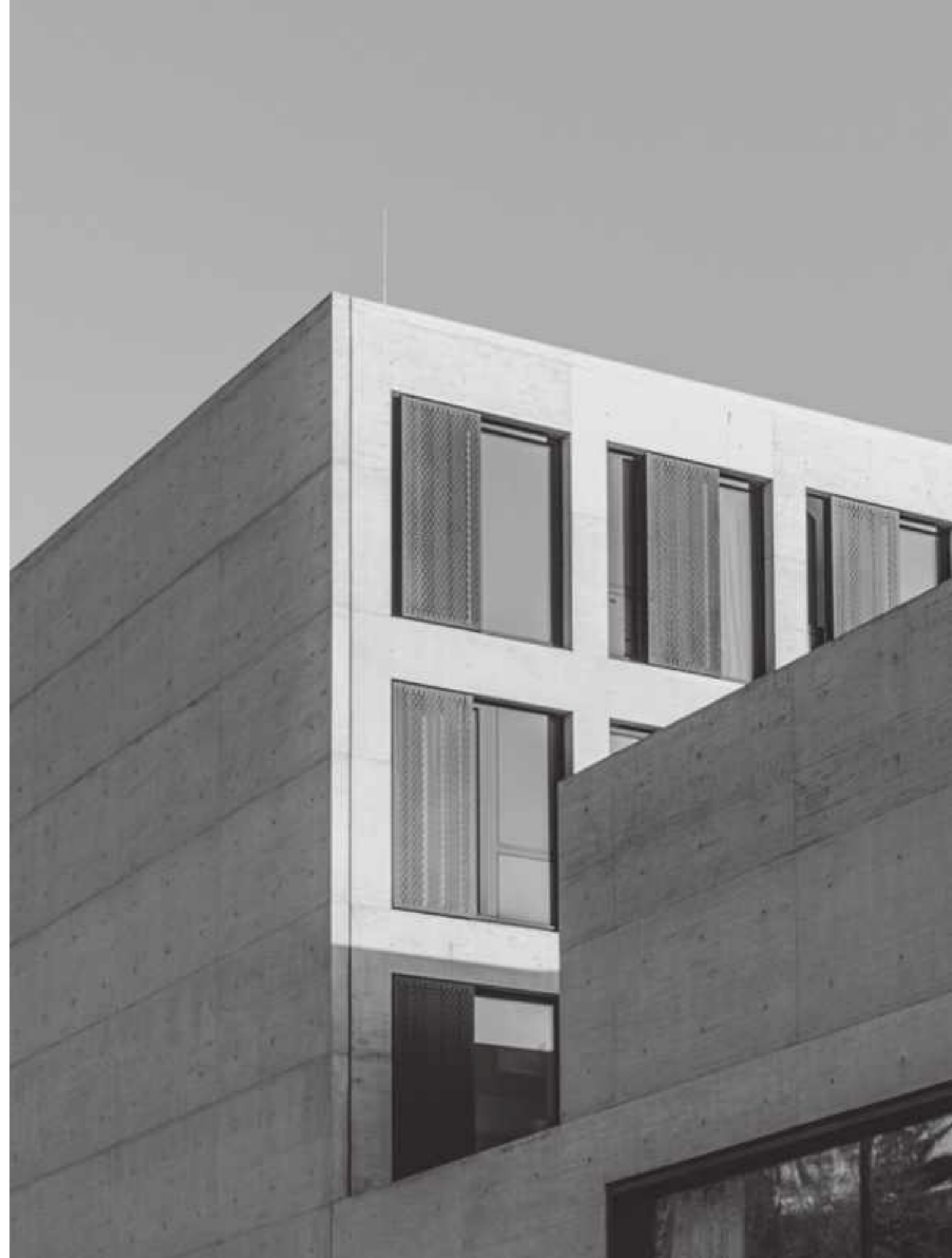





Modular freestanding shelves, 800 mm wide. The shelves, with rounded corners, have trims on both ends that conceal the interior of the profile. Versions up to three shelves high have 250 mm bases. To guarantee stability, from four shelves it has 420 mm bases that can be hidden with a trim. Optionally, it can integrate 800 mm sliding panels, in front or rear position. Combinable with the rest of the references in the collection. The maximum recommended height is seven shelves. ENG

Estantería modular *freestanding* de 800 mm de ancho. Los estantes, de ángulos redondeados, llevan embellecedores en ambos extremos para ocultar el interior del perfil. Las versiones de hasta tres estantes de altura llevan bases de 250 mm. Para garantizar la estabilidad, a partir de cuatro estantes lleva bases de 420 mm que pueden ocultarse con un embellecedor. Opcionalmente puede integrar paneles deslizantes de 800 mm, en posición frontal o posterior. Combinable con el resto de referencias de la colección Wing. La altura máxima recomendada es de siete estantes. ESP

# 800 Freestanding Shelves

800 Freestanding Shelves /  
3 shelves / black



800 Freestanding Shelves /  
5 shelves / black

Accessories:  
(1x) 800 mm panel /  
silver grey  
(2x) 800 mm profiles /  
silver grey



The best size for  
small spaces





Desk 1600 mm long, with shelves that can be used to store books, office materials, decorative items, etc. With this piece of furniture, the collection reinforces its possible use as a key piece for remote working from home. Designed for individual use or to form compositions with the Wing shelves. The board can be requested in a natural oak finish, or white, or black industrialized laminate. Available in two versions: wall-mounted and freestanding.

ENG

Escritorio de 1600 mm de longitud cuyas baldas permiten la colocación de libros, materiales de oficina, adornos, etc. Con este mueble, la colección refuerza su posible uso como pieza clave para ejercer el teletrabajo desde casa. Pensado para su uso individual o formando composiciones con las estanterías Wing. El tablero puede solicitarse en acabado roble natural o laminado industrializado blanco o negro. Disponible en dos versiones: a pared y autoportante.

ESP

(1x) 1600 Freestanding Desk /  
black / natural oak board



# Desk

Wing

Desk





COMPOSITION 16  
1600 Wall Desk  
1600 Wall Shelves  
800 Wall Shelves  
page 134

Open wardrobe that simultaneously makes it possible to organise clothes, shoes, bags and other accessories thanks to the way it unites the hanging rod with shelves. Designed for individual use or combined with other elements of the same unit, as well as forming compositions with the Wing shelves. Available in two sizes, 1600 and 800 mm; and two versions, wall-mounted and freestanding.

Armario abierto que posibilita al mismo tiempo la organización de ropa, zapatos, bolsos y otros accesorios, gracias a la forma en que combina la barra de colgar con baldas. Pensado para su uso individual o combinado con otras unidades del mismo, así como formando composiciones con las estanterías Wing. Disponible en dos medidas, 1600 y 800 mm; y dos versiones, a pared y autoportante.

ENG

(1x) 800 Freestanding Shelves /  
7 shelves / silk grey  
(1x) 1600 Freestanding  
Wardrobe / silk grey /  
chrome-plated hanging rod

Accessories:  
(4x) joints / silk grey

ESP



# Wardrobe



COMPOSITION 17  
1600 Wall Wardrobe  
1600 Wall Shelves  
800 Wall Shelves  
1600 Bench  
*page 135*



1600 mm long bench with upholstery available in three 100 % recycled finishes. Ideal to be placed at the foot of a bed. This piece of furniture is a practical two-in-one: being upholstered, it becomes a comfortable seat and, thanks to its lower shelf, it offers extra space to store plaids, shoes, cushions, books or other objects.

ENG

(1x) 1600 Bench / silk grey /  
light grey N51 upholstery

Banco de 1600 mm de longitud con tapicería disponible en tres acabados 100 % reciclados. Ideal para ser ubicado a los pies de una cama. Este mueble es un práctico dos en uno: al ser tapizado, resulta un asiento cómodo y, gracias a su repisa inferior, ofrece un espacio extra para guardar *plaids*, zapatos, cojines, libros u otros objetos.

ESP



# Bench



New models  
to upgrade  
your space



1600 mm wide TV stand designed for individual use or to form compositions with the Wing shelves. Includes a rear panel that hides the connections. Supports screens up to 70 inches, with a maximum width of 1600 mm. VESA 100, 200, 300, 400 and 600 mounting interface standard. Both in its home and office versions, this product can be wall-mounted or freestanding. Includes a rear cover that hides the connections.

ENG

Soporte de televisores de 1600 mm de ancho diseñado para su uso individual o formando composiciones con las estanterías Wing. Incluye una trasera que oculta las conexiones. Admite pantallas de hasta 70 pulgadas, con un ancho máximo de 1600 mm. Estándar de interfaz de montaje VESA 100, 200, 300, 400 y 600. Tanto en sus versiones *home* como en su versión *office*, este producto admite ser colocado a pared o de forma autoportante. Incluye una tapa trasera que oculta las conexiones.

ESP

(1x) 1600 Freestanding  
Home TV Stand / white



(1x) 1600 Freestanding  
Office TV Stand / white



# TV Stand

Wing

TV Stand



Accessories created to extend and complement the functional nature of the system. Their variety in size allows for an infinite number of uses, both decorative as well as functional and organisational. The design is adapted to the dimensions of the collection.

ENG

Accesorios creados para ampliar y complementar la naturaleza funcional del sistema. Su variedad en tamaño permite infinidad de usos, tanto decorativos como funcionales y de organización. El diseño está adaptado a las dimensiones de la colección.

ESP

# Accessories



The panels are housed between shelves and can be placed interchangeably in front of and behind the shelf. The shelves have discrete cavities that act as rails and allow these sliding panels to be anchored.

*Los paneles se alojan entre estantes y pueden colocarse indistintamente delante y detrás de la estantería. Los estantes constan de discretas cavidades que hacen la función de carriles y permiten el anclaje de estos paneles deslizantes.*



Natural oak veneer for sliding panels.

*Chapado de roble natural para los paneles deslizantes.*



Accessory designed to join the shelves of two shelvings placed continuously.

*Accesorio pensado para unir las baldas de dos estanterías colocadas de forma continua.*



Profiles made of steel that lengthen the lower shelf and hide the bases. Only for 420 mm bases.

*Perfiles fabricados en acero que alargan el estante inferior y ocultan las bases. Solo para bases de 420 mm.*

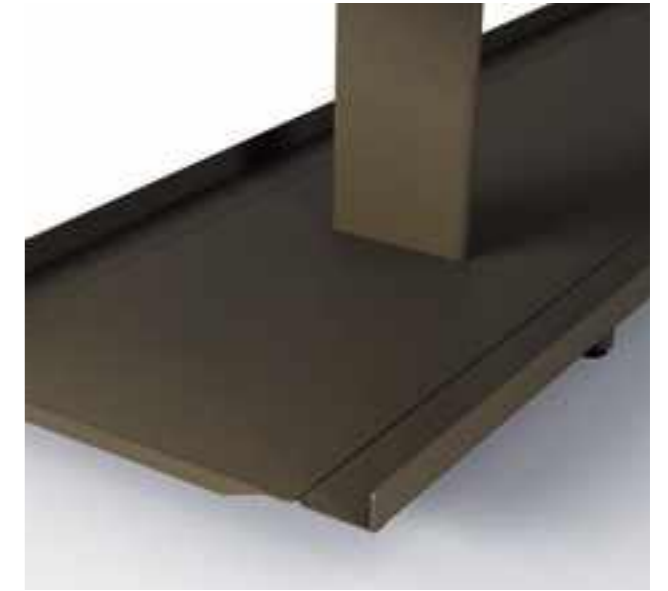

Panels  
Paneles

Oak interior/external veneer  
Chapado interior/external roble

Joint  
Junta

Profile  
Perfil

The front edge provides a lip at the front of the shelves to prevent objects from falling. It can be placed indistinctly in front of or behind the shelving and on any of its levels.

*El tope de estante proporciona un borde frontal a las baldas para evitar la caída de objetos. Puede colocarse indistintamente delante o detrás de la estantería y en cualquiera de sus niveles.*



Front edge  
Tope de estante

Separate plate to be placed on top of the last shelf to hide the connecting screws. Available in: Techlam Kalos Bianco porcelain, Techlam Tempesta porcelain, matt natural oak and painted aluminum in any of the 10 colors of the collection.

*Plancha independiente que se coloca encima de la última balda para ocultar los herrajes de unión. Disponible en: porcelánico Techlam Kalos Bianco, porcelánico Techlam Tempesta, roble natural mate y aluminio pintado en cualquiera de los 10 colores de la colección.*



Premium top board  
Tablero superior premium

Accessory that delimits the storage space of the shelves at one or both ends.

*Accesorio que delimita el espacio de almacenaje de la estantería por uno de sus extremos o ambos.*



Side enclosure  
Cerramiento lateral





Tray to place small objects. It has an interior felt that protects the drawer and objects. There is the possibility of adding a mobile divider.

*Bandeja para colocar pequeños objetos. Lleva un fieltro interior que protege el cajón y los objetos. Existe la posibilidad de añadirle un separador móvil.*



Small tray  
Bandeja  
pequeña

It is the widest tray of the Wing accessories. It has an interior felt that protects the tray and the objects that are placed on it. It is very suitable for storing folios and paper documents. There is the possibility of adding two mobile dividers.

*Es la bandeja más amplia de los accesorios Wing. Lleva un fieltro interior que protege la bandeja y los objetos que se pongan encima. Resulta muy indicada para guardar folios y documentos de papel. Existe la posibilidad de añadirle dos separadores móviles.*

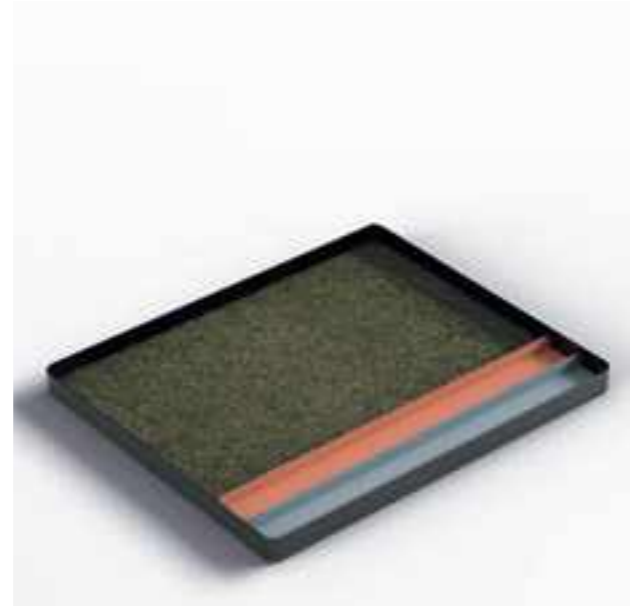

Tray  
Bandeja

Tall container to store all kinds of objects. It has an interior felt that protects the drawer and objects. There is the possibility of adding a mobile divider.

*Contenedor alto para almacenar todo tipo de objetos. Lleva un fieltro interior que protege el cajón y los objetos. Existe la posibilidad de añadirle un separador móvil.*



Drawer  
Cajón

Box designed to store index cards, standard A4-size hanging folders and other documents in an orderly manner. This accessory cannot be used on those shelves with panels.

*Caja diseñada para guardar fichas, carpetas colgantes estándar tamaño A4 y otros documentos de manera ordenada. Este accesorio no se puede usar en aquellas baldas con paneles.*



File holder  
Archivador

Tray, small tray, drawer and file holder on a Wing shelf.

*Bandeja, bandeja pequeña, cajón y archivador en una estantería Wing.*

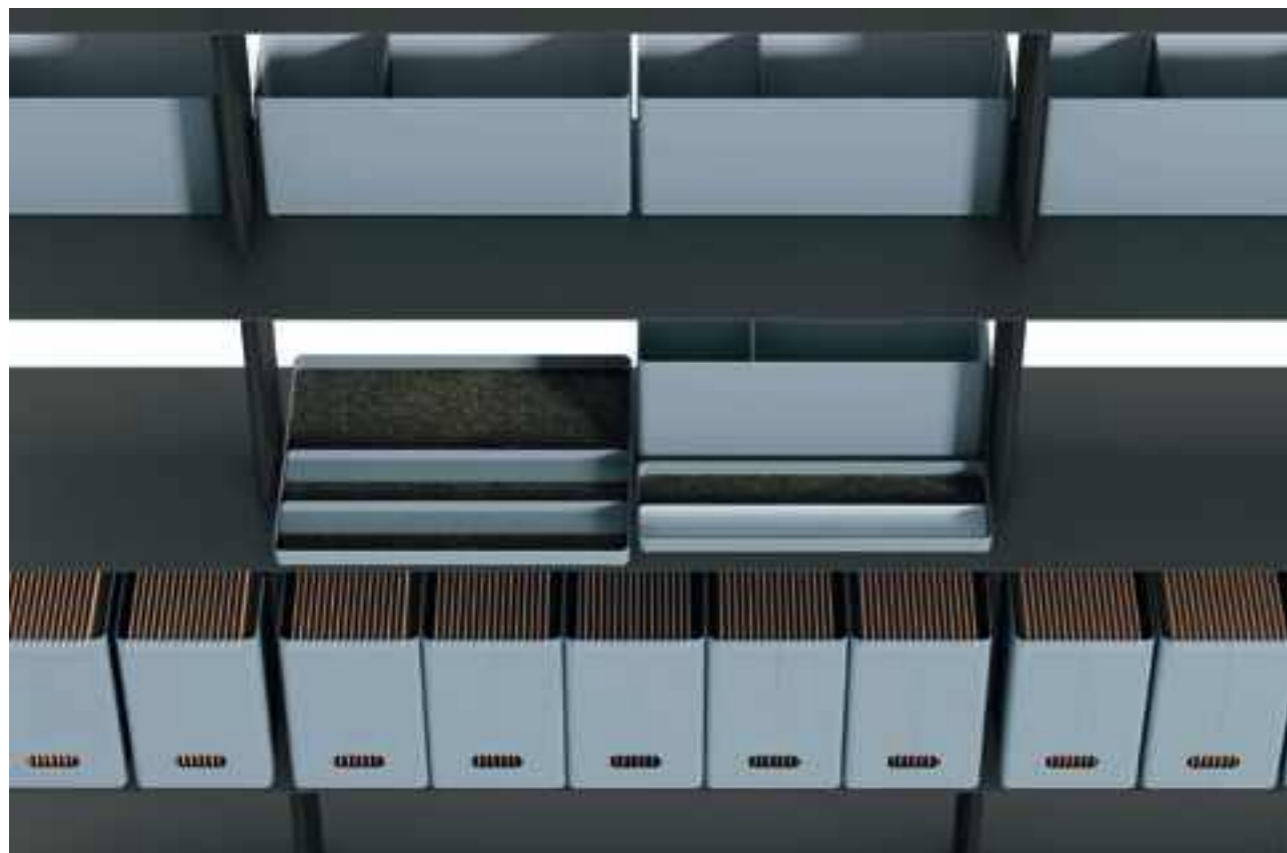

Tray, small tray, drawer and file holder.

*Bandeja, bandeja pequeña, cajón y archivador.*

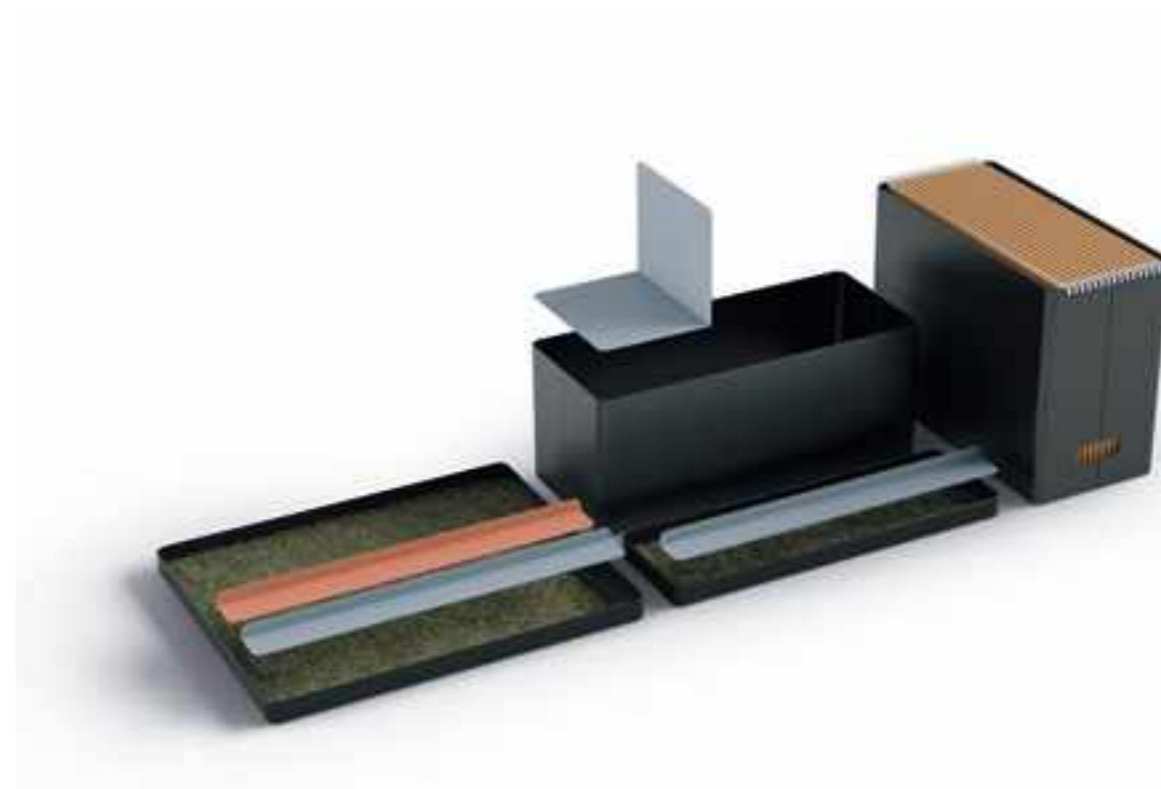

Practical and discreet accessory for book holding.  
Available in two sizes.

*Accesorio práctico y discreto para sostener libros.  
Disponible en dos tamaños.*



Small bookend  
Sujetalibros  
pequeño

Bookend  
Sujetalibros





# Technical Details

## Wall & Freestanding Shelves

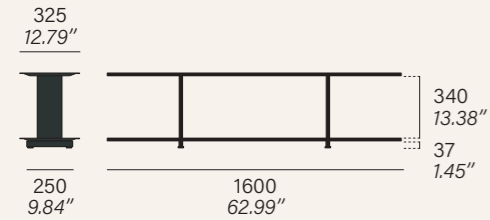

## Freestanding Shelves

420 mm bases from 4 shelves.  
Bases de 420 mm a partir de 4 estantes.

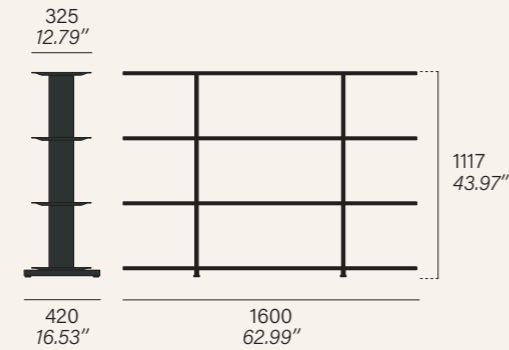

## Accessories Wall & Freestanding Shelves

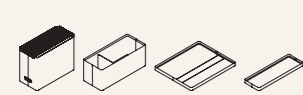

Container accessories  
*Accesorios contenedores*

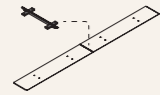

Joint  
*Junta*

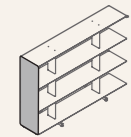

Side enclosure  
*Cerramiento lateral*

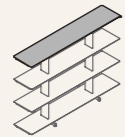

Premium top board  
*Tablero superior premium*



Front edge  
*Tope de estante*

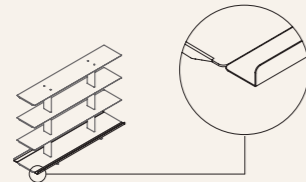

Profile for 420 mm bases  
*Perfil para bases de 420 mm*

Only for freestanding models  
*Solo para modelos freestanding*

## 1600

## Wall & Freestanding Shelves

Panel composition examples.  
*Ejemplos de composiciones de paneles.*

2 shelves

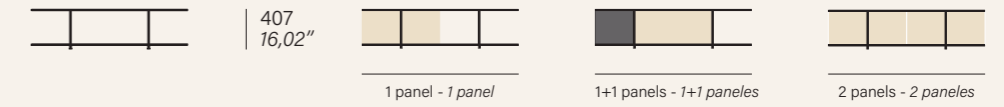

3 shelves

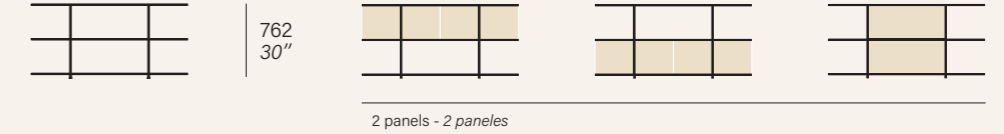

4 shelves

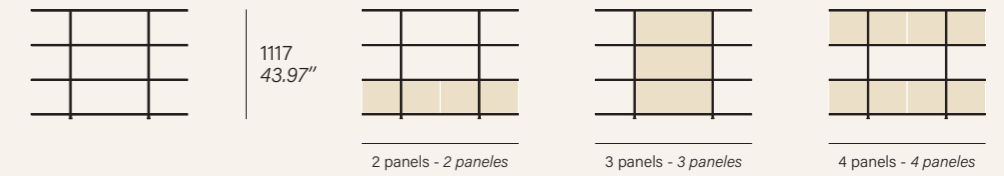

5 shelves

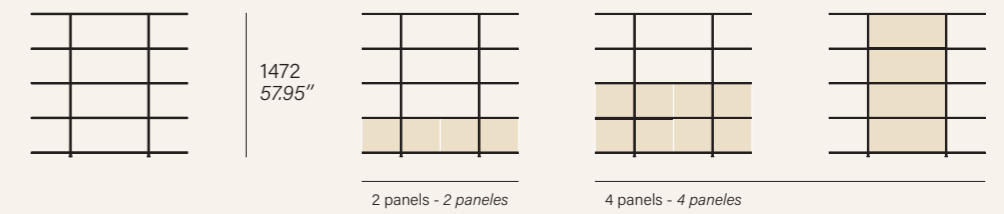

6 shelves

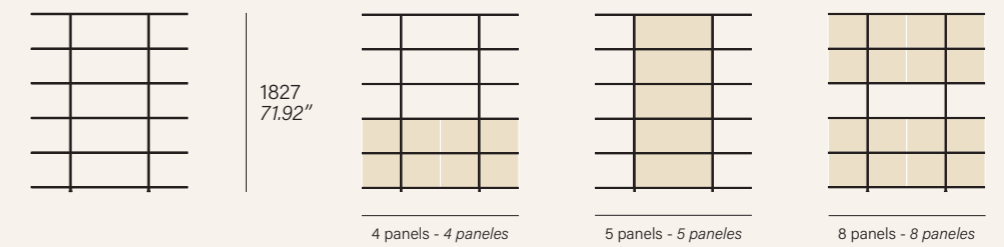

7 shelves

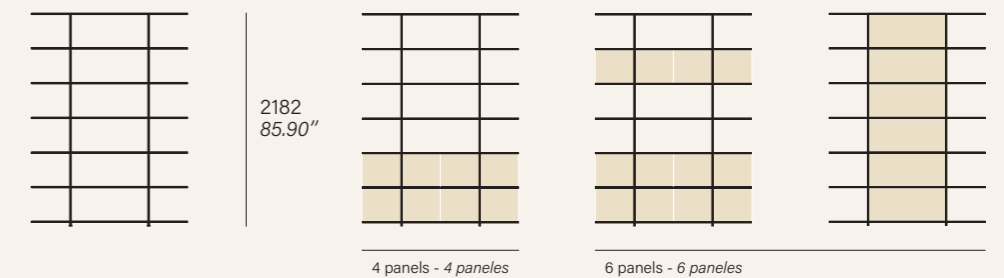

■ Panels 400x343mm  
■ Panels 800x343mm

# Corner Shelves

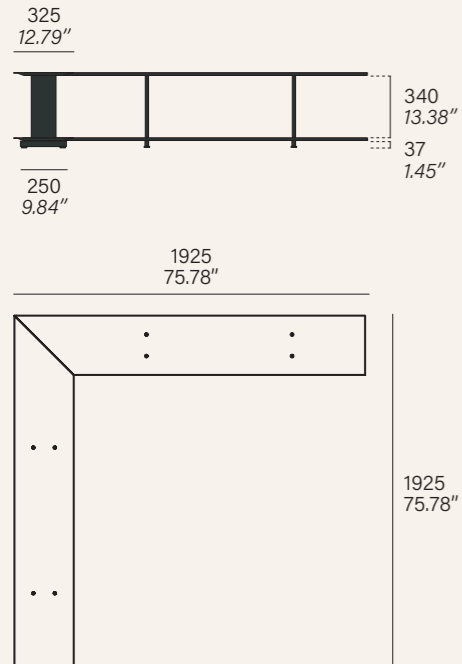

## Accessories Corner Wall & Freestanding Shelves

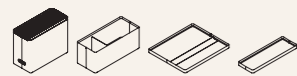

Container accessories  
*Accesorios contenedores*

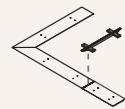

Joint  
*Junta*

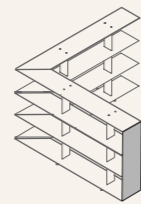

Side enclosure  
*Cerramiento lateral*

# 1600

2 shelves

3 shelves

4 shelves

5 shelves

6 shelves

7 shelves

# Corner Shelves

Panel composition examples.  
*Ejemplos de composiciones de paneles.*

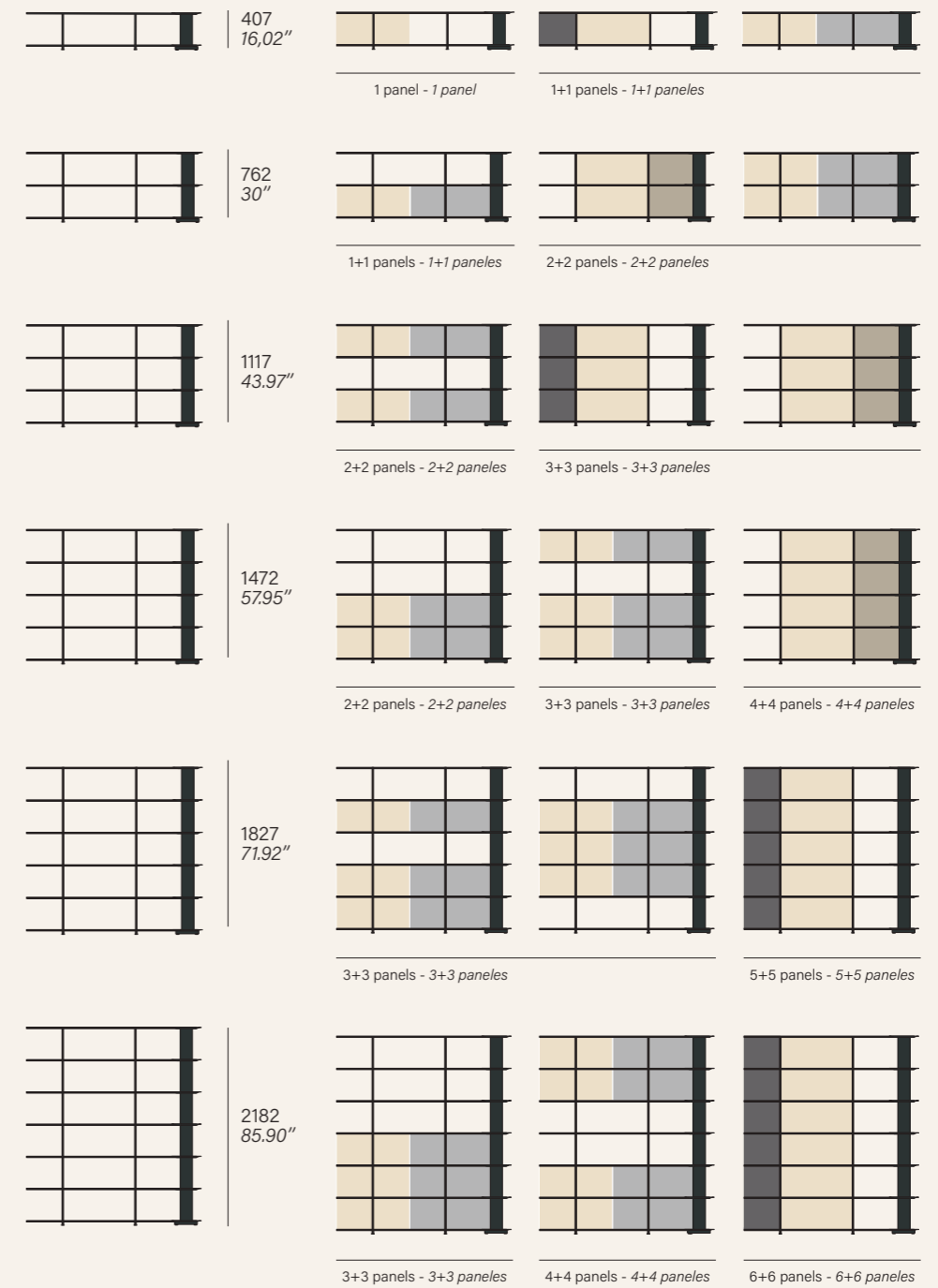

Panels 400x343mm  
 Panels 725x343mm  
 Panels 800x343mm  
 Panels 1125x343mm  
 Paneles 400x343mm  
 Paneles 725x343mm  
 Paneles 800x343mm  
 Paneles 1125x343mm



# Wall & Freestanding Shelves

# Freestanding Shelves

420 mm bases from 4 shelves.  
Bases de 420 mm a partir de 4 estantes.

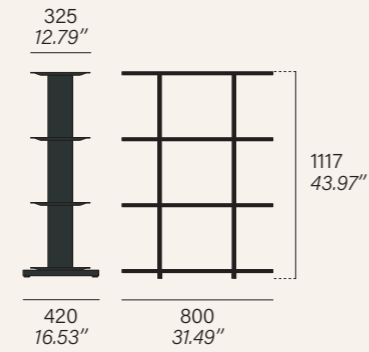
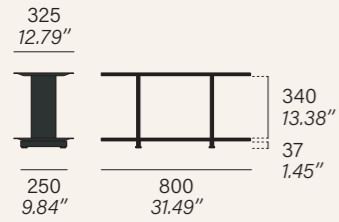

## Accessories Wall & Freestanding Shelves

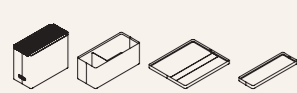

Container accessories  
*Accesorios contenedores*

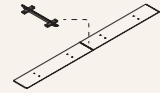

Joint  
*Junta*

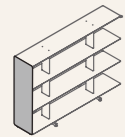

Side enclosure  
*Cerramiento lateral*

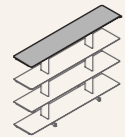

Premium top board  
*Tablero superior premium*

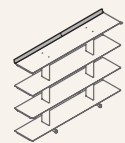

Front edge  
*Tope de estante*

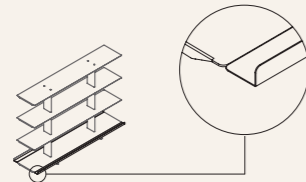

Profile for 420 mm bases  
*Perfil para bases de 420 mm*

Only for freestanding models  
*Solo para modelos freestanding*

# 800

# Wall & Freestanding Shelves

Panel composition examples.  
*Ejemplos de composiciones de paneles.*

2 shelves

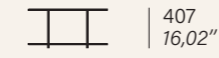

407  
16.02"



1 panel  
*1 panel*

3 shelves



762  
30"



1 panel  
*1 panel*



2 panels  
*2 paneles*

4 shelves



1117  
43.97"



1 panel  
*1 panel*



2 panels  
*2 paneles*



2 panels  
*2 paneles*



2 panels  
*2 paneles*

5 shelves



1472  
57.95"



1 panel  
*1 panel*



2 panels  
*2 paneles*

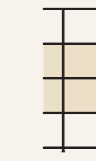

3 panels  
*3 paneles*



3 panels  
*3 paneles*

6 shelves



1827  
71.92"



2 panels  
*2 paneles*



3 panels  
*3 paneles*



3 panels  
*3 paneles*



3 panels  
*3 paneles*

7 shelves

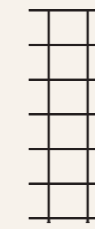

2182  
85.90"



2 panels  
*2 paneles*



3 panels  
*3 paneles*



4 panels  
*4 paneles*



4 panels  
*4 paneles*

Panels 800x343mm  
*Paneles 800x343mm*

# Desk

1600 Desk Wall Freestanding

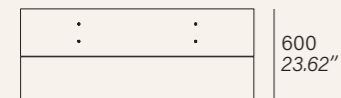
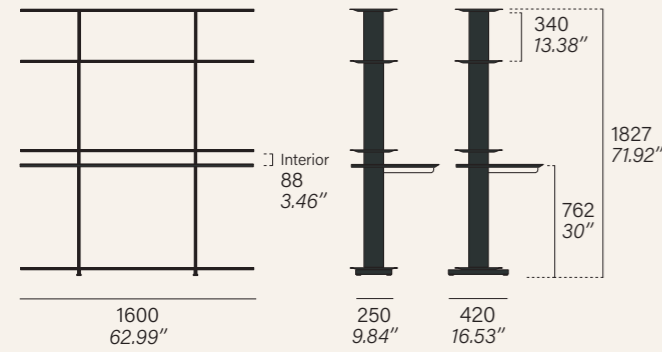

This module must be fixed to the floor or to the wall. Anchors included.  
*Este módulo debe ser fijado a suelo o a pared. Anclajes incluidos.*

Matches height with 6-shelf Wing shelving.  
*Coincide en altura con estanterías Wing de 6 estantes.*

# Basic Desk

1600 Basic desk Wall Freestanding

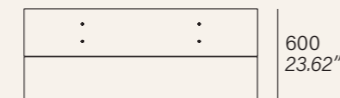
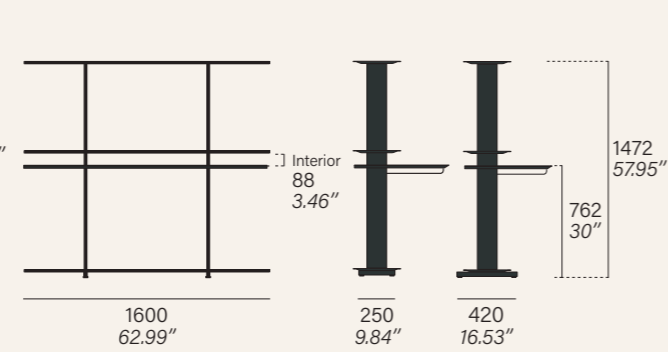

Matches height with 5-shelf Wing shelving.  
*Coincide en altura con estanterías Wing de 5 estantes.*

# Wardrobe

1600 Wardrobe Wall Freestanding

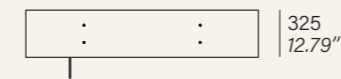
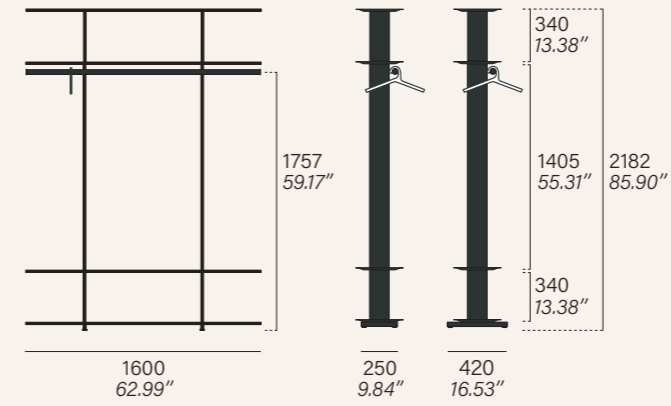

Floor anchoring available.  
Hangers not included.  
*Se ofrece anclaje a suelo. Perchas no incluidas.*

Matches height with 7-shelf Wing shelving.  
*Coincide en altura con estanterías Wing de 7 estantes.*

# Basic Wardrobe

1600 Basic wardrobe Wall Freestanding

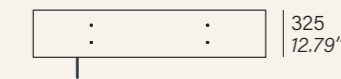
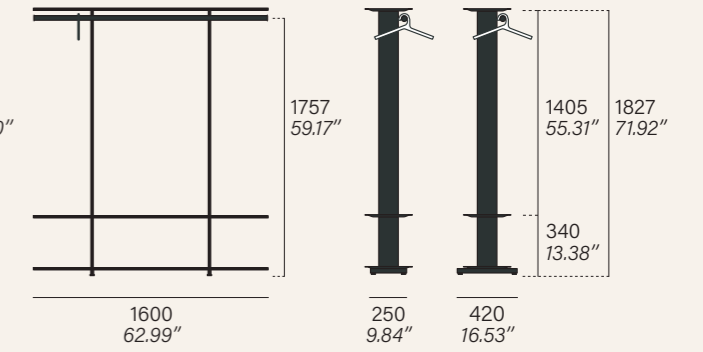

Matches height with 6-shelf Wing shelving.  
*Coincide en altura con estanterías Wing de 6 estantes.*

# Bench

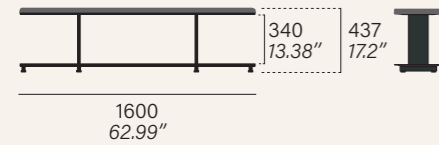

800 Wardrobe Wall Freestanding

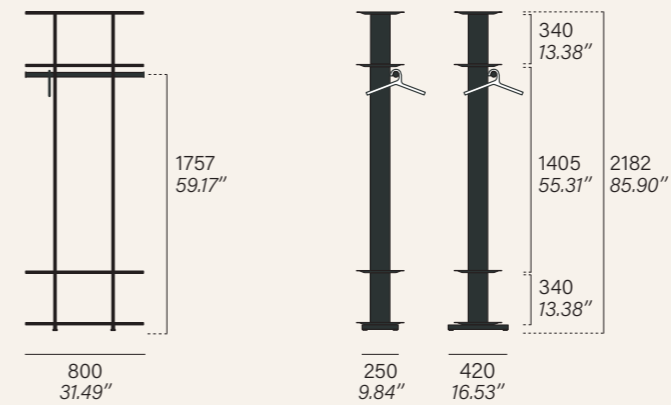

Floor anchoring available.  
Hangers not included.  
*Se ofrece anclaje a suelo. Perchas no incluidas.*

Matches height with 7-shelf Wing shelving.  
*Coincide en altura con estanterías Wing de 7 estantes.*

800 Basic wardrobe Wall Freestanding

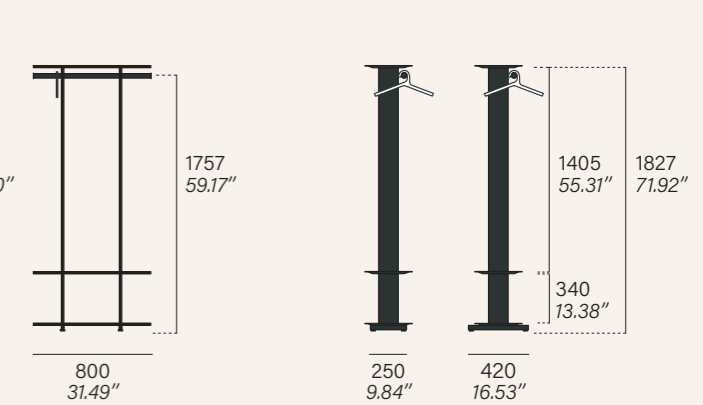

Matches height with 6-shelf Wing shelving.  
*Coincide en altura con estanterías Wing de 6 estantes.*

# Home TV Stand

1600 Home TV stand

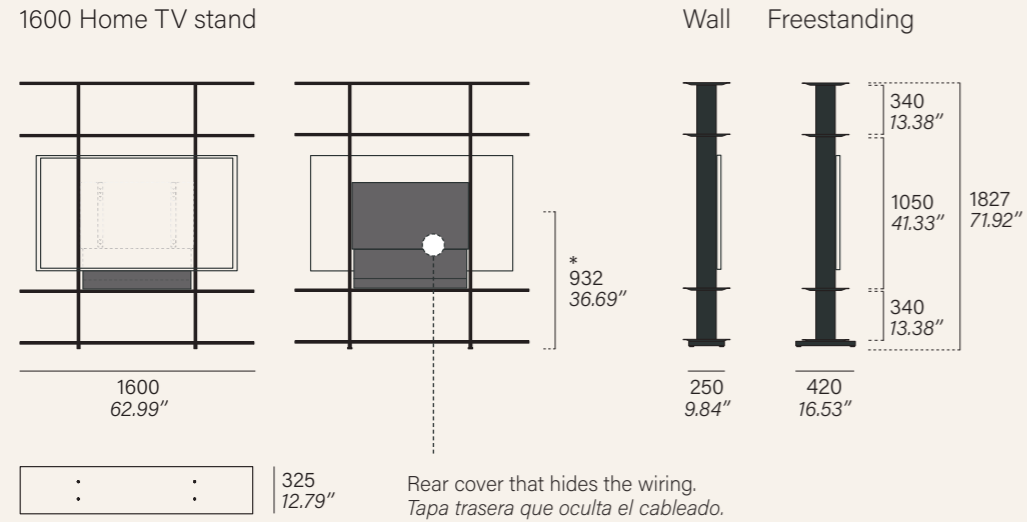

Floor anchoring available.  
*Se ofrece anclaje a suelo.*

Matches height with 6-shelf Wing shelving.  
*Coincide en altura con estanterías Wing de 6 estantes.*

# Office TV Stand

1600 Office TV stand

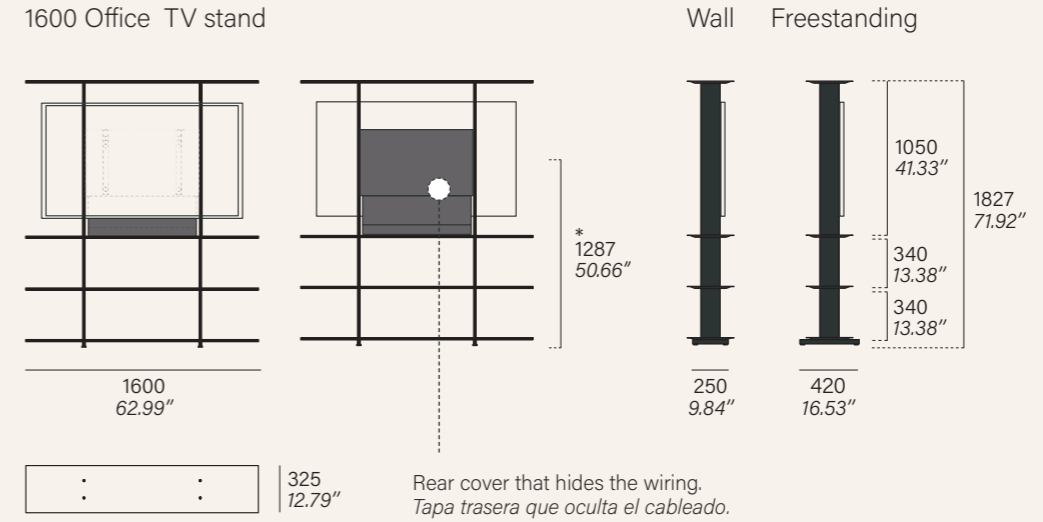

Floor anchoring available.  
*Se ofrece anclaje a suelo.*

Matches height with 6-shelf Wing shelving.  
*Coincide en altura con estanterías Wing de 6 estantes.*

# Home Basic TV Stand

1600 Home Basic TV stand

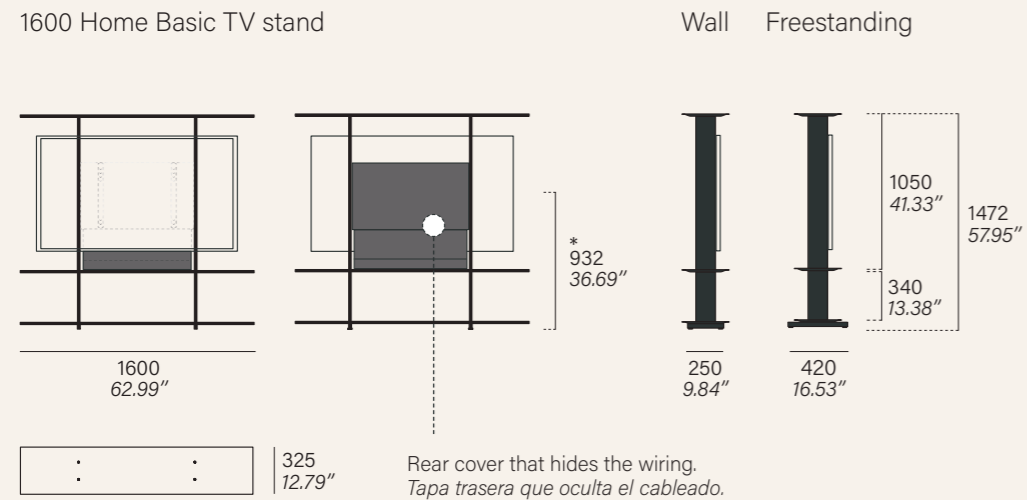

Floor anchoring available.  
*Se ofrece anclaje a suelo.*

Matches height with 5-shelf Wing shelving.  
*Coincide en altura con estanterías Wing de 5 estantes.*

## GENERAL TV STAND INFORMATION

Supports screens up to 70 inches, with a maximum width of 1600 mm.  
VESA 100, 200, 300, 400 and 600 mounting interface standard.  
*Admite pantallas de hasta 70 pulgadas, con un ancho máximo de 1600 mm. Estándar de interfaz de montaje VESA 100, 200, 300, 400 y 600.*

\* Approximate TV height measurement.  
It depends on the television and the height adjustment in the assembly.  
*Medida de altura de TV aproximada. Depende del televisor y de la regulación en altura en el montaje.*



## Panels

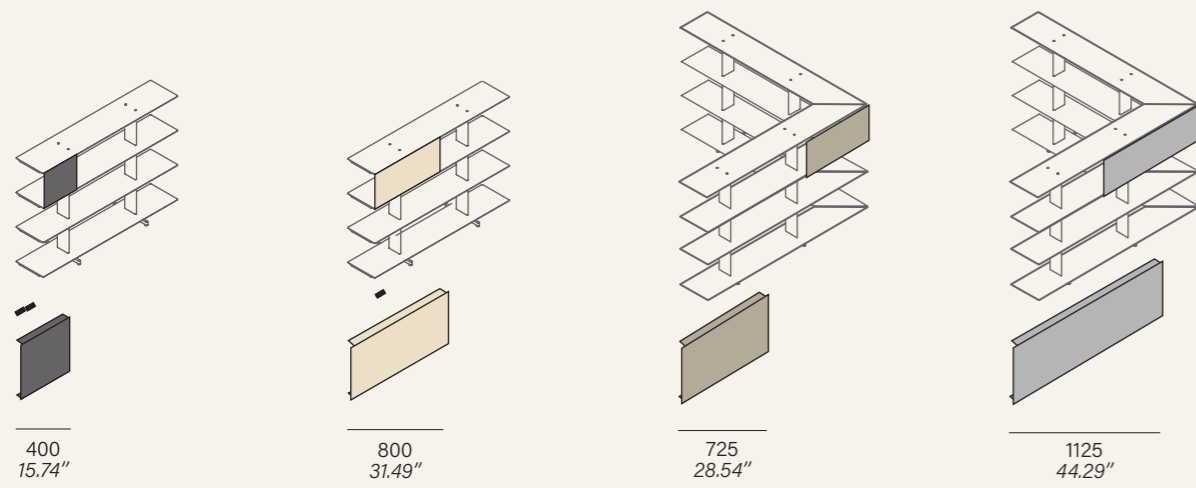

## Joint

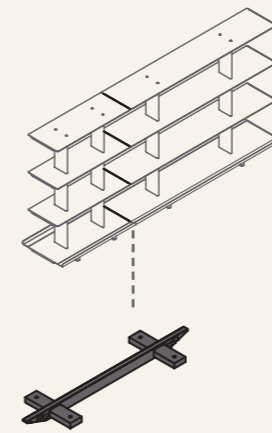

## Profile

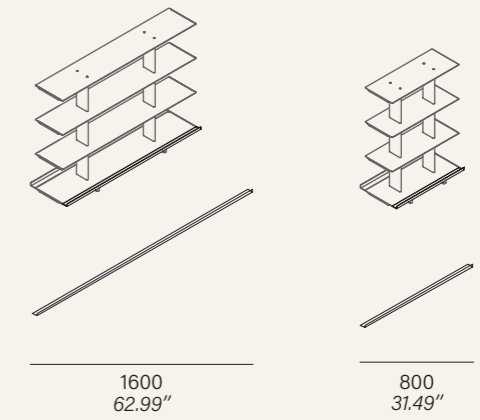

## Oak interior/exterior veneer for panels

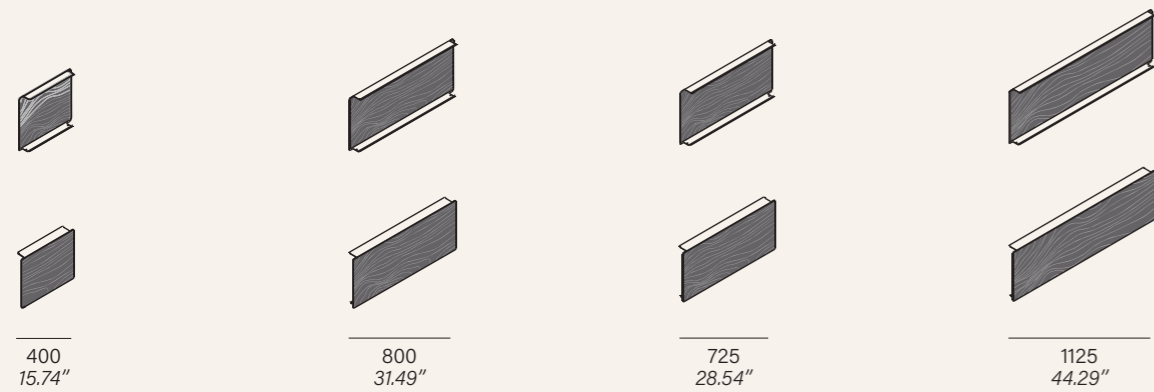

## Front edge

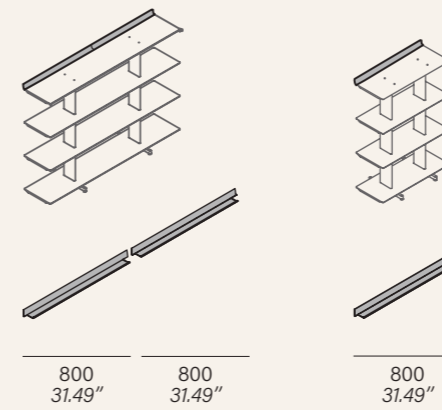

## Premium top board

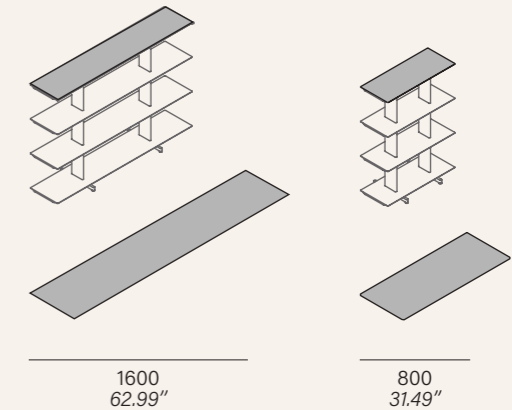

Side enclosure

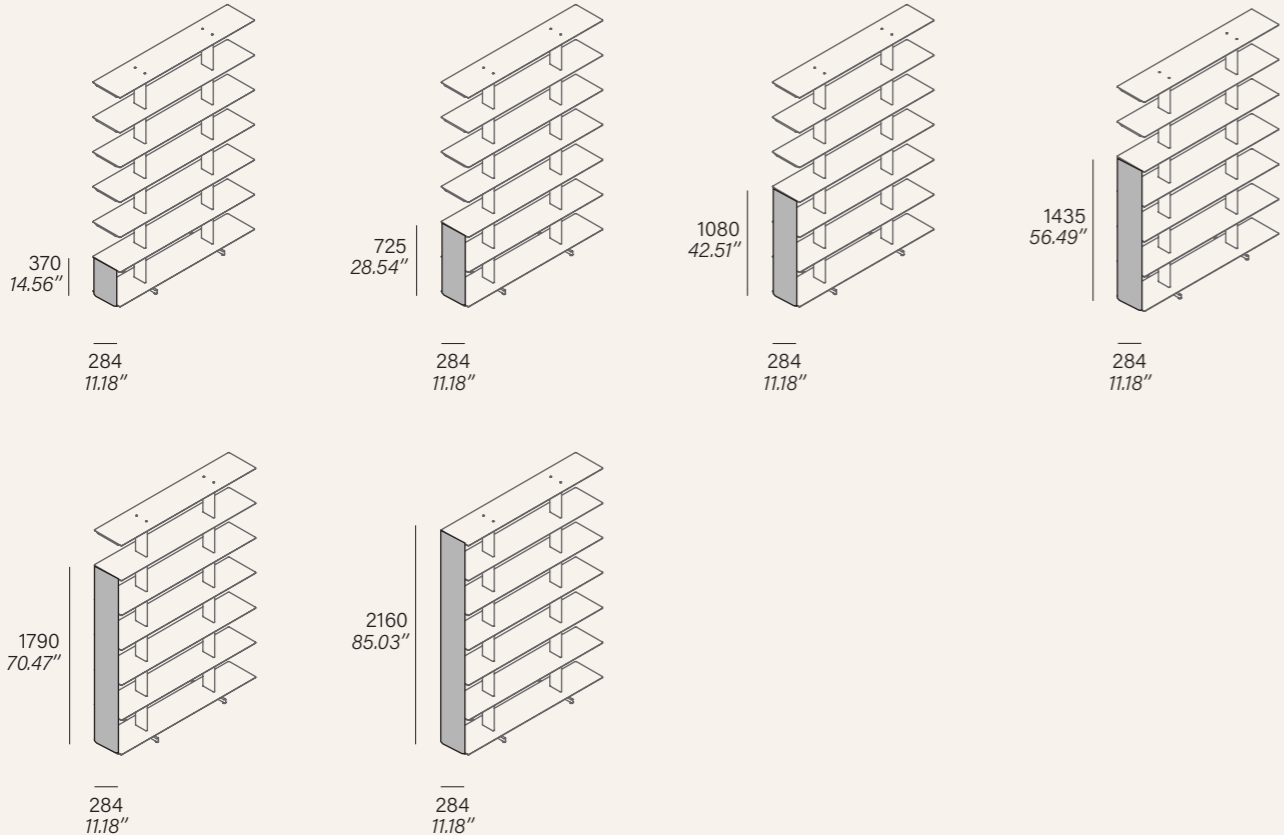

Small tray

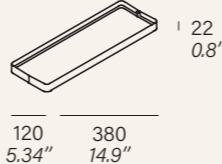

Tray

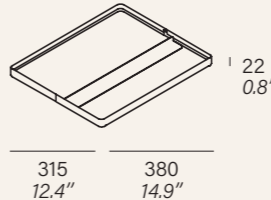

Drawer

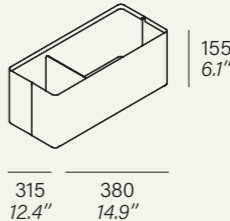

File holder

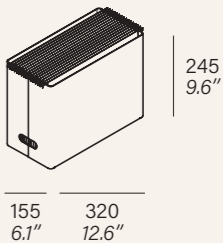

Small bookend

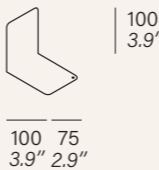

Bookend

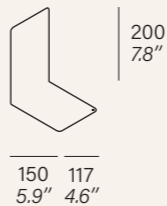

# Compositions



# Composition 1

Page 18 & 20-21

(3x) 1600 Wall Shelves /  
7 shelves / white

## Accessories:

(6x) 800 mm panels / white  
(14x) joints / white

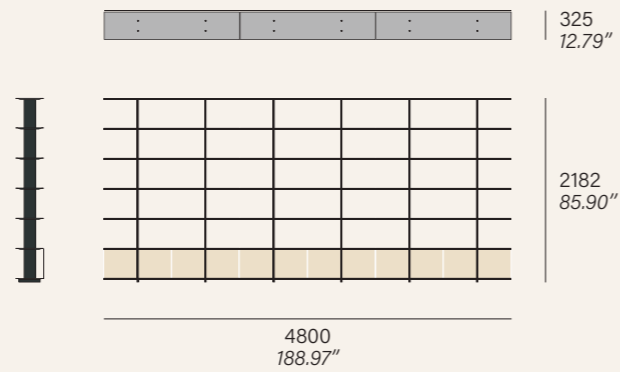

# Composition 2

Page 22-23

## 2A (x1)

(2x) 1600 Freestanding Shelves /  
2 shelves / bronze bagana

## Accessories:

(4x) 800 mm panels / bronze bagana  
(2x) premium top board / Techlam  
Tempesta

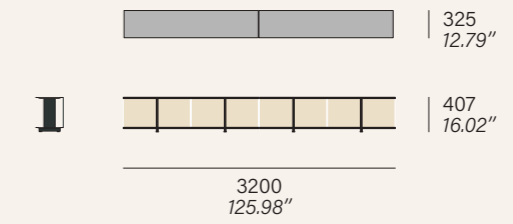

## 2B (x1)

(3x) 1600 Wall Shelves / 2 shelves /  
bronze bagana

## Accessories:

(6x) 800 mm panels / bronze bagana  
(3x) premium top board / Techlam  
Tempest

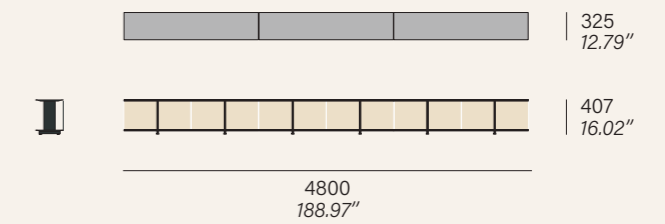

## 2C (x1)

(3x) 1600 Wall Shelves /  
6 shelves / bronze bagana

## Accessories:

(2x) side enclosure for 6 shelves /  
bronze bagana  
(12x) joints / bronze bagana

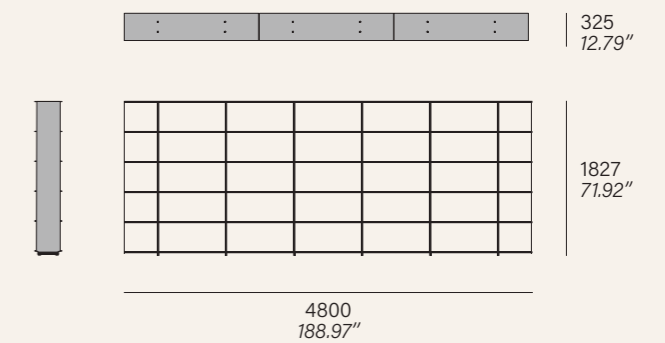

# Composition 3

Page 26-27

## 3A (x2)

(1x) 1600 Freestanding Shelves / 7 shelves / black

### Accessories:

- (6x) 800 mm panel / black
- (6x) oak interior veneer for 800 mm panel
- (6x) oak exterior veneer for 800 mm panel
- (6x) front edge / black
- (2x) 1600 mm profiles / black
- (1x) floor anchoring / black

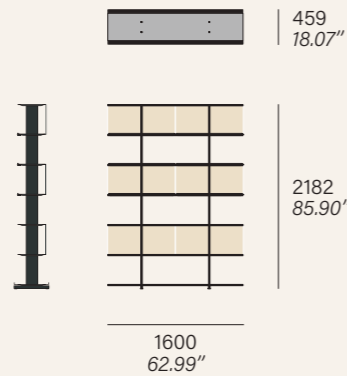

## 3B (x3)

(1x) 1600 Wall Shelves / 7 shelves / black

### Accessories:

- (6x) 800 mm panel / black
- (6x) oak interior veneer for 800 mm panel
- (6x) front edge / black

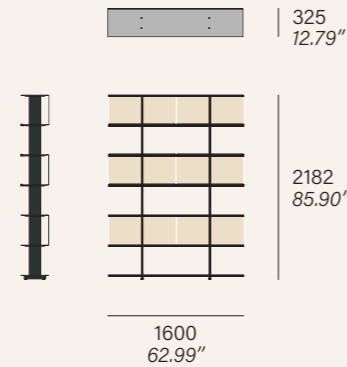

# Composition 4

Page 30-31

(2x) 1600 Wall Shelves / 7 shelves / black

### Accessories:

- (8x) joints / black

### Progression items:

- (2x) a 1600 mm shelf unit / black
- (2x) two vertical upstand units / black

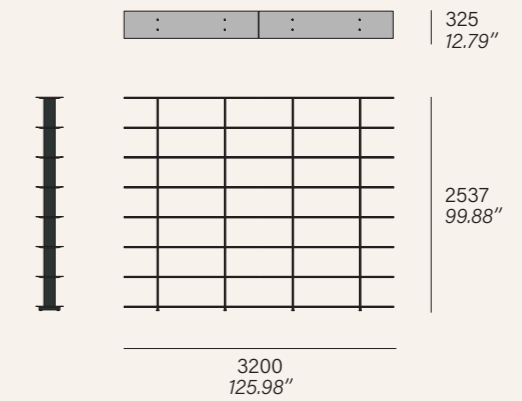

# Composition 5

Page 34-35

## 5A (x2)

(1x) 1600 Wall Shelves / 6 shelves / black

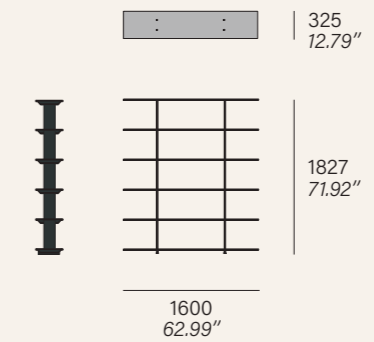

## 5B (x2)

(1x) 1600 Freestanding Shelves / 6 shelves / black

### Accessories:

- (1x) floor anchoring / black

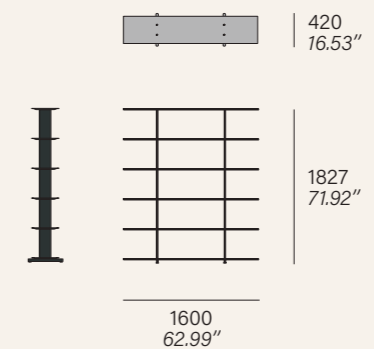

# Composition 6

Page 38-39

## 6 (x4)

(1x) 1600 Freestanding Shelves / 6 shelves / black

### Accessories:

- (2x) side enclosure for 6 shelves / black
- (4x) 800 mm panels / black
- (4x) oak interior veneer for 800 mm panels
- (4x) oak exterior veneer for 800 mm panels
- (1x) floor anchoring / black

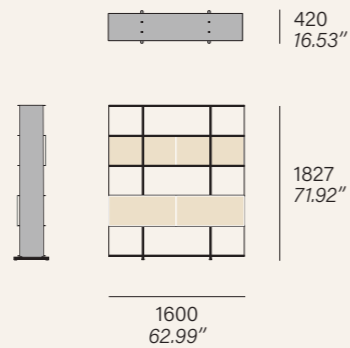

# Composition 7

Page 42-43

## 7A (x5)

(2x) 1600 Freestanding Shelves / 6 shelves / black

### Accessories:

- (2x) side enclosure for 6 shelves / black
- (6x) joints / black
- (2x) floor anchoring / black

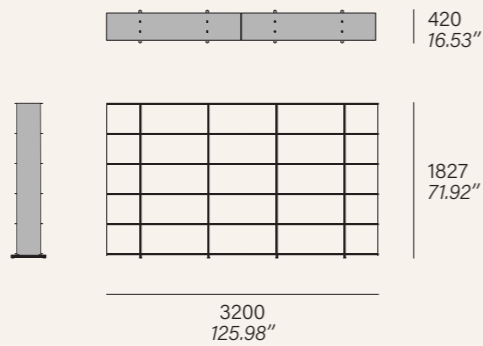

## 7B (x3)

(2x) 1600 Wall Shelves / 6 shelves / black

### Accessories:

- (2x) side enclosure for 6 shelves / black
- (6x) joints / black

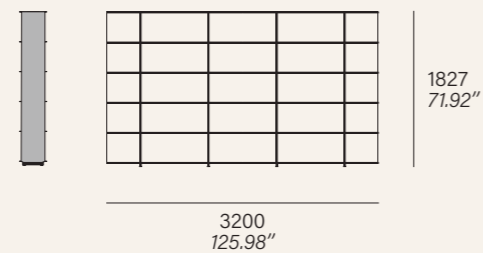

# Composition 8

Page 46-47

## 8A (x1)

(2x) 1600 Freestanding Shelves / 3 shelves / black

### Accessories:

- (4x) 800 mm panels / black
- (2x) 400 mm panels / black
- (4x) oak interior veneer for 800 mm panels
- (2x) oak exterior veneer for 400 mm panels
- (3x) joints / black

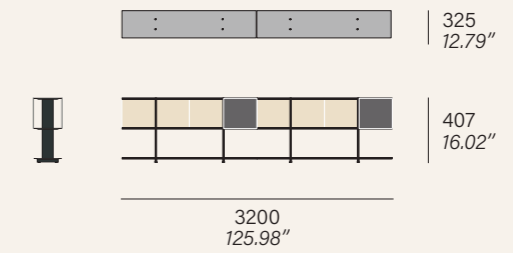

## 8B (x1)

(2x) 1600 Wall Shelves / 3 shelves / black

### Accessories:

- (4x) 800 mm panels / black
- (2x) 400 mm panels / black
- (4x) oak interior veneer for 800 mm panels
- (2x) oak exterior veneer for 400 mm panels
- (3x) joints / black

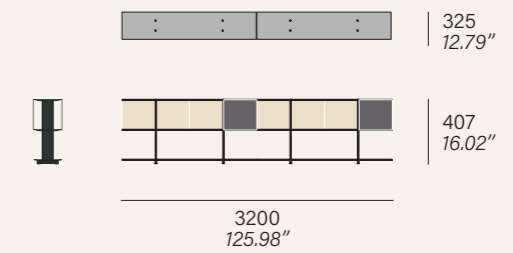



# Composition 9

Page 50-51

9 (x2)

(1x) 1600 Corner Shelves / 6 shelves / black

### Accessories:

- (6x) 400 mm panel / black
- (6x) 725 mm panel / black
- (6x) 800 mm panel / black
- (6x) oak interior veneer for 400 mm panel
- (6x) oak interior veneer for 725 mm panel
- (6x) oak interior veneer for 800 mm panel

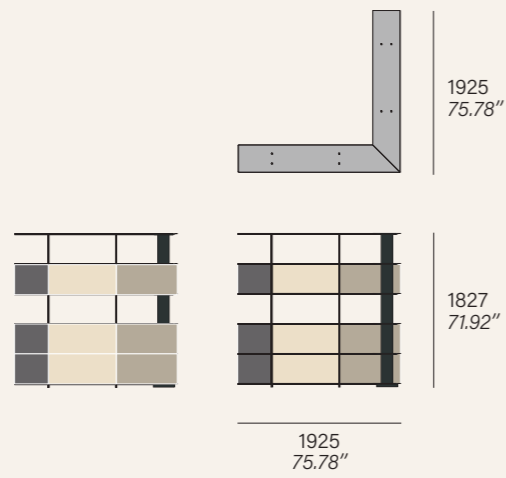

# Composition 10

Page 54-55

(2x) 1600 Corner Shelves / 6 shelves / black  
(3x) 1600 Freestanding Shelves / 6 shelves / black

### Accessories:

- (12x) 1125 mm panels / white
- (30x) 800 mm panels / white
- (24x) joints / black

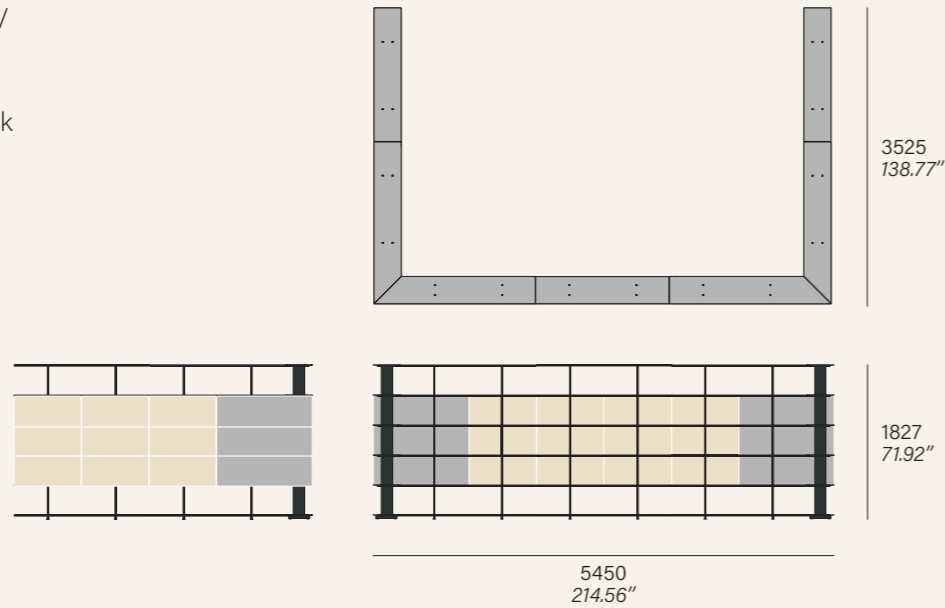

# Composition 11

Page 56-57

11A (x1)

(1x) 1600 Corner Shelves / 6 shelves / black  
(2x) 1600 Freestanding Shelves / 6 shelves / black

### Accessories:

- (18x) 800 mm panels / bronze bagana
- (12x) joints / black

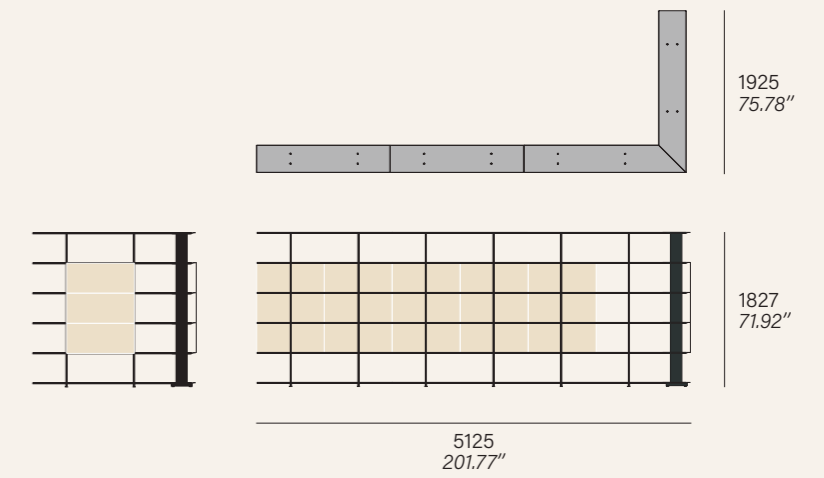

11B (x1)

(1x) 1600 Corner Shelves / 6 shelves / black  
(3x) 1600 Freestanding Shelves / 6 shelves / black

### Accessories:

- (6x) 1125 mm panels / bronze bagana
- (21x) 800 mm panels / bronze bagana
- (18x) joints / black

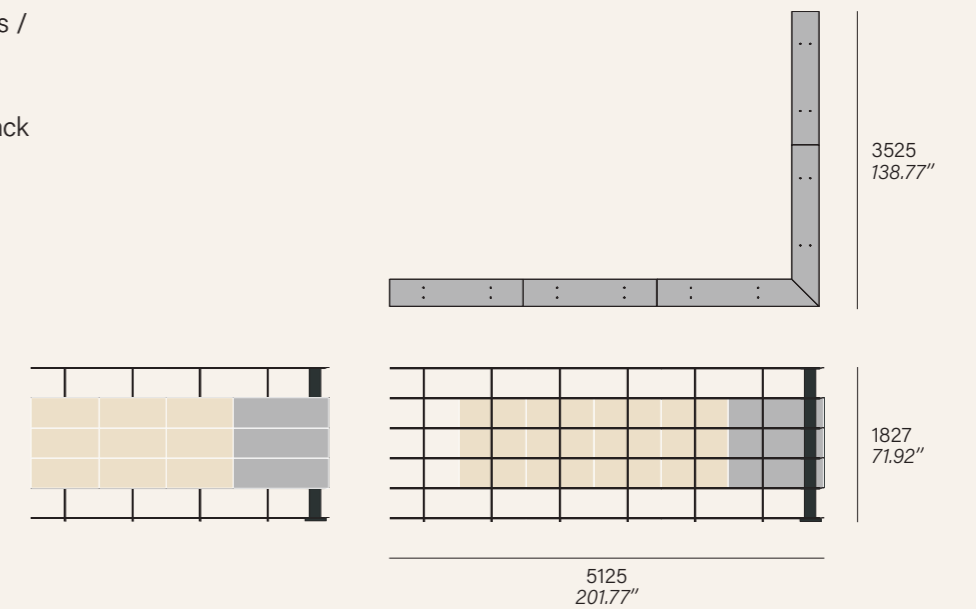

# Composition 12

Page 60-61

- (1x) 1600 Corner Shelves / 7 shelves / forged grey
- (2x) 1600 Wall Shelves / 7 shelves / forged grey
- (1x) 1600 Wall Shelves / 4 shelves / forged grey

### Accessories:

- (6x) 400 mm panel / forged grey
- (6x) 725 mm panel / forged grey
- (20x) 800 mm panel / forged grey
- (6x) oak interior veneer for 400 mm panel
- (6x) oak interior veneer for 725 mm panel
- (20x) oak interior veneer for 800 mm panel
- (18x) joints / forged grey

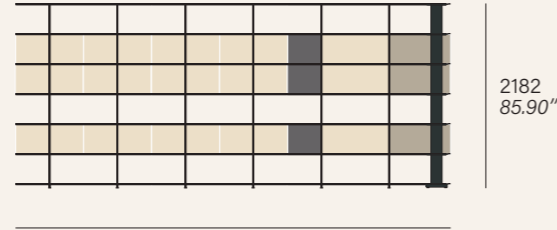
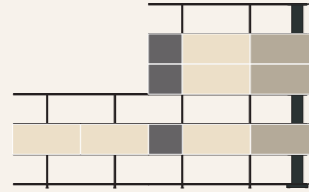

# Composition 13

Page 62-63

- (1x) 1600 Corner Shelves / 7 shelves / black
- (4x) 1600 Wall Shelves / 7 shelves / black

### Accessories:

- (28x) joints / black

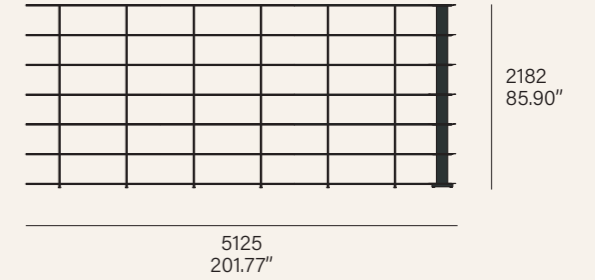
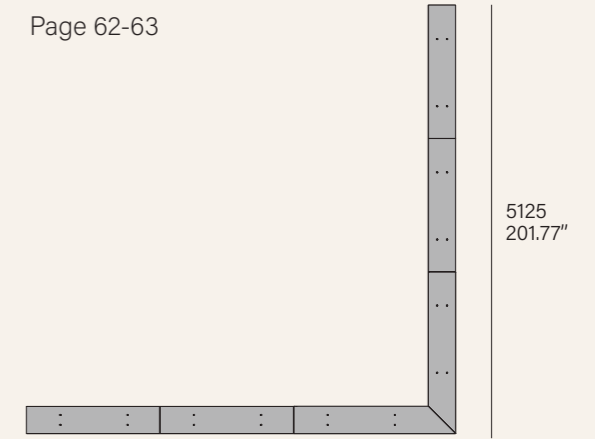

# Composition 14

Page 65 & 68

- (1x) 800 Wall Shelves / 2 shelves / bronze bagana

### Accessories:

- (1x) 800 mm panels / bronze bagana
- (1x) 800 mm premium top board / Techlam Tempesta porcelain

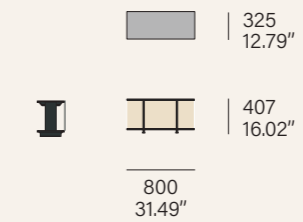

# Composition 15

Page 74-75

## 15 (x2)

(1x) 800 Freestanding Shelves / 7 shelves / black

### Accessories:

(1x) floor anchoring / black

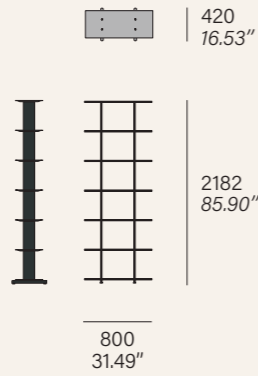

# Composition 16

Page 78-79

(1x) 1600 Wall Shelves / 6 shelves / black  
 (1x) 800 Wall Shelves / 6 shelves / black  
 (1x) 1600 Wall Desk / black / natural oak board

### Accessories:

(6x) joints / black

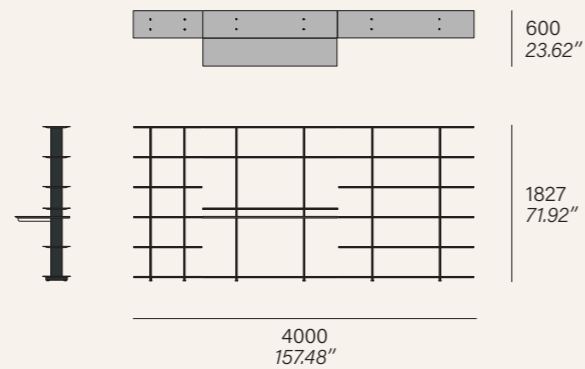

# Composition 17

Page 82-83

## 17A (x1)

(1x) 1600 Wall Shelves / 7 shelves / silk grey  
 (2x) 800 Wall Shelves / 7 shelves / silk grey  
 (1x) 1600 Wall Wardrobe / silk grey / chrome-plated hanging rod

### Accessories:

(28x) 800 mm panels / silk grey  
 (28x) oak interior veneer for 800 mm panel  
 (15x) joints / silk grey

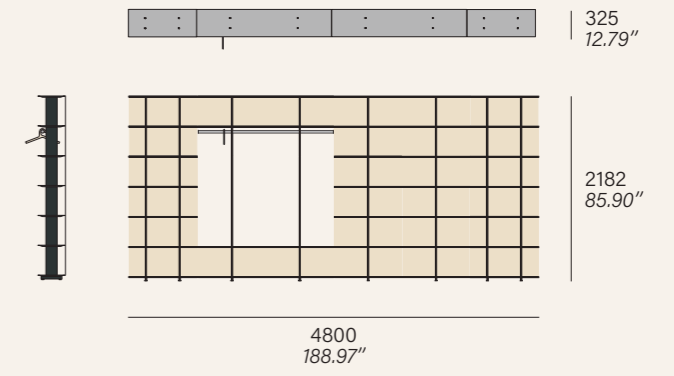

## 17B (x1)

(1x) 1600 Bench / silk grey / beige N07 upholstery

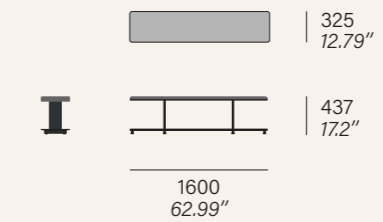



# Composition 18

Page 86

(1x) 1600 Bench / silk grey / light grey N51 upholstery

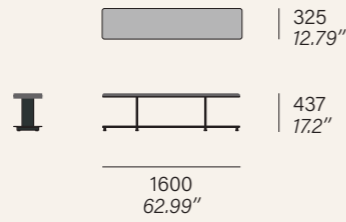

# Composition 19

Page 90-91

(2x) 1600 Wall Shelves / 6 shelves / black  
(1x) 1600 Wall Home TV Stand / black

Accessories:  
(8x) joints / black

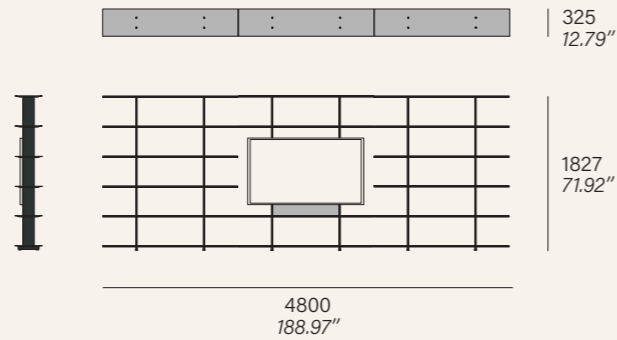

# Composition 20

Page 98-99

## 20A (x1)

(4x) 1600 Freestanding Shelves / 7 shelves / silk grey

### Accessories:

(40x) 800 mm panels / silk grey  
(21x) joints / silk grey  
(4x) floor anchoring / silk grey

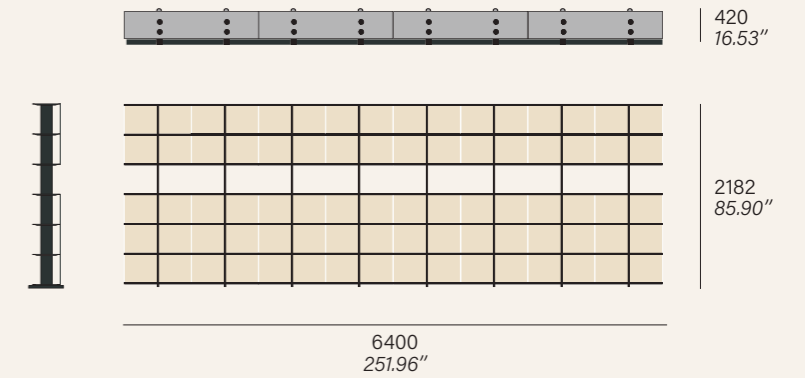

## 20B (x1)

(4x) 1600 Wall Shelves / 4 shelves / silk grey

### Accessories:

(4x) 1600 mm premium top board / silk grey painted aluminum  
(12x) joints / silk grey

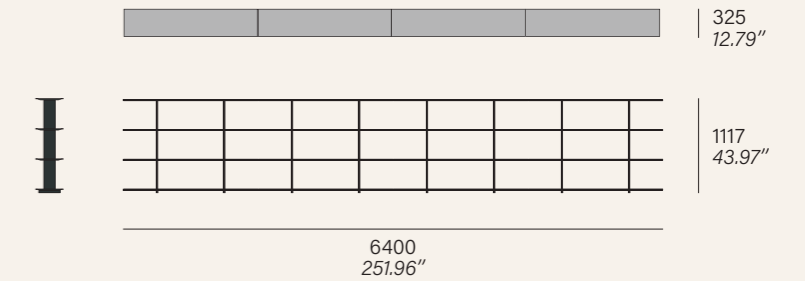

## 20C (x1)

(1x) 1600 Freestanding Shelves / 3 shelves / silk grey

### Accessories:

(1x) 1600 mm premium top board / silk grey painted aluminum

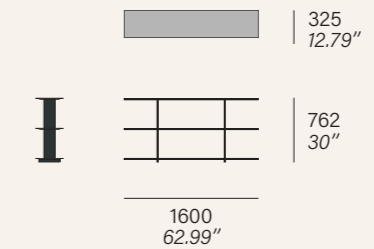

From Systemtronic we would like to thank all the companies that have collaborated in the accomplishment of this catalog.

ENG

Desde Systemtronic agradecemos a todas las empresas que han colaborado en la realización de este catálogo.

ESP

# Thanks

**MOROSO<sup>™</sup>**

**arper**

**Artemide<sup>®</sup>**

**lzf**

VIBIA

**viccarbe**

  
**SANTA & COLE**

**nanimarquina**

**Blasco&Vila**

**jmm**  
josé martínez medina

**FLOS**

**vitra.**

STUA

**ESSENZIALED<sup>®</sup>**  
Led Lighting | www.essenzialed.com

**BLACK TONE** by José Martínez Medina

**G/IV**

